



Advanced Computer Systems



Instrument Processing Facility L1b

Doc. No.: CS-RS-ACS-GS-5106
Issue: 4.0
Date: 10/12/2007
Page: 1

Deleted: 3.

Deleted: 2

Deleted: 3

Deleted: 07

CRYOSAT Ground Segment

Instrument Processing Facility L1b

Products Specification Format

[PROD-FMT]

CS-RS-ACS-GS-5106

Issue: 4.0

Date: 10/12/2007

Deleted: 3.

Deleted: 2

Deleted: 3

Deleted: 07



Advanced Computer Systems



Instrument Processing Facility L1b

Doc. No.: CS-RS-ACS-GS-5106
Issue: 4.0
Date: 10/12/2007
Page: 2

Deleted: 3.

Deleted: 2

Deleted: 3

Deleted: 07

Document Signature Table

APPROVAL TABLE		
Date		
Name	Function	Signature
C. ZELLI	ACS Project Manager	
P. VIAU	ESA Project Manager	
G. RATIER	Cryosat Project Manager	

CONTRACTOR TABLE				
	Name	Function	Signature	Date
Author	ACS Team MSSL Team			
Verification	C. ZELLI S. BAKER	IPF1 Project Manager MSSL Team Responsible		
Quality Assurance	O.GUERRA	Quality Manager		
Approval	C. ZELLI	IPF1 Project Manager		

Distribution List

Internal Distribution	
Name	No. Copies
N. Vacca	1
T. Geminale	1
M. Antonacci	1
F. Carriero	1
P. Mantovani	1
V. Spaventa	1
A. Vollono	1
R. Medri	1

External Distribution		
Company	Name	No. Copies
ESA	P. Viau	1
ESA	Betlem Rosich	1
MSSL	S. Baker	1
ARESIS	Davide Daria	1



Advanced Computer Systems



Instrument Processing Facility L1b

Doc. No.: CS-RS-ACS-GS-5106
Issue: 4.0
Date: 10/12/2007
Page: 3

Deleted: 3.

Deleted: 2

Deleted: 3

Deleted: 07

Document Change Record

Issue/Rev.	Class (R=Review /A=Approval)	Date	Reason for Change	Changed Pages/Paragraphs
Cryosat 1				
1	R	10/04/2002	Initial Issue for SRR	all
1.8	R	17/05/2002	Update for Co-location Meeting	See side bars
1.9	R	12/07/2002	Comments following Co-Location Meeting Delivery for ADR	See side bars
2.0	R	20/12/2002	Outcomes of Actions issued in the ADR Meeting.	See side bars
2.1	R	25/02/2003	Alignment of document for Va 2.0 SW re-delivery. The following items are covered in this update: SPR93 Definition of Start and Stop Time in product filenames and product MPH as for CS-MN-ACS-GS-5217 Correction of Percentage fields from 10-3 to 10-2 in Product Headers NOTE THAT THIS IS AN INTERIM VERSION OF THE PROD_FMT: FURTHER CHANGES ALREADY DISCUSSED DURING FAT-VA WILL BE INCLUDED AFTER VA 2.0 REDELIVERY TO ALLOW CORRECT DEVELOPMENT OF VB SW PROCESSORS.	See side bars

Formatted Table



Advanced Computer Systems



Instrument Processing Facility L1b

Doc. No.: CS-RS-ACS-GS-5106
 Issue: 4.0
 Date: 10/12/2007
 Page: 4

Deleted: 3.

Deleted: 2

Deleted: 3

Deleted: 07

Issue/Rev.	Class (R=Review /A=Approval)	Date	Reason for Change	Changed Pages/Paragraphs
2.2	A	25/04/2003	Global Revision of Product Headers and Update of Records Structure	
2.3	A	13/06/2003	Includes updates of MCD fields and CAL1 / CAL2 product layouts as per agreements in MoM CS-MS-ACS-GS-5219	
2.4	A	20/10/2003	Update of CAL3 L1B and SARIN L1B Product Layouts as for agreements with MSSL Inclusion of NPM quality flag in FBR and L1B MCD Modification of CAL1-SARIN MCD definition to separate quality information of Rx1 and Rx2 channels. Inclusion of Platform Attitude Control flag in MODE_ID field Inclusion of SAR/SARIN processing specific flags in MCD for L1B product Revision of Product Header.	
2.5	A	30/11/2003	Inclusion of statement about the exotic units in products Inclusion of scaling factors in Monitoring Products	
2.6	A	31/01/2004	Inclusion of scaling factors in CAL1 Products + XML DSD definition + typographical	
2.7	A	26/11/2004	Inclusion of Exotic CAL1 Product + corrections	
2.8	A	16/05/2005	XML and ASCII SPH	



Advanced Computer Systems



Instrument Processing Facility L1b

Doc. No.: CS-RS-ACS-GS-5106
 Issue: ~~4.0~~
 Date: 10/12/2007
 Page: 5

Deleted: 3.

Deleted: 2

Deleted: 3

Deleted: 07

			<p>modified to introduce Surface Id Statistics fields (Task#6 IPF1-CCN6)</p> <p>List of DS_NAME for Measurement DSD updated to account for Fast Delivery Ocean Processing Chain.</p> <p>FBR and L1B MCD updated: obsolete External COM Correction bit field removed; flags to trace exotic CAL1 file have been introduced</p> <p>IPF1 Products List updated with FDM products</p>	
2.9	A	02/08/2005	Inclusion of fields descriptions	
3.0	A	09/09/2005	Typo errors corrections	See Sidebars
3.1	A	24/06/2006	Inclusion of new DS Name for new geocorrections files	See Sidebars
3.2	A	10/07/2007	Definition of 'Flags' field in SAR Average Waveform Group added	See Sidebars
Cryosat 2				
4.0	R	12/12/2007	Vh 1.0 delivery (SIRAL redundancy)	See Sidebars

Formatted Table

Deleted: 3.3

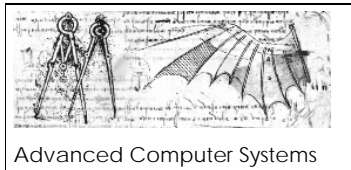

Instrument Processing Facility L1b

Doc. No.: CS-RS-ACS-GS-5106
 Issue: 4.0
 Date: 10/12/2007
 Page: 6

- Deleted: 3
- Deleted: 2
- Deleted: 3
- Deleted: 07

TABLE OF CONTENTS

1	INTRODUCTION	8
1.1	PURPOSE AND SCOPE	8
1.2	DOCUMENT STRUCTURE.....	8
1.3	APPLICABLE & REFERENCE DOCUMENTS	9
1.3.1	<i>Applicable Documents.....</i>	<i>9</i>
1.3.2	<i>Reference Documents.....</i>	<i>9</i>
1.4	ACRONYMS AND ABBREVIATIONS	10
2	LEVEL-1 GENERAL FORMAT DESCRIPTION	11
2.1	FILE STRUCTURE	12
2.2	XML HEADER FILE	13
2.2.1	<i>Fixed Header (Cryosat Header).....</i>	<i>13</i>
2.2.2	<i>Variable Header (Product Header).....</i>	<i>14</i>
2.2.2.1	XML Main Product Header (XML MPH)	14
2.2.2.2	XML Specific Product Header (XML SPH).....	17
2.3	PRODUCT FILES.....	23
2.3.1	<i>Main Product Header (MPH)</i>	<i>24</i>
2.3.2	<i>Specific Product Header (SPH).....</i>	<i>31</i>
2.3.3	<i>FBR LRM(FDM)/SAR/SARin MDS Record Structure</i>	<i>42</i>
2.3.4	<i>FBR CAL3 MDS Record Structure.....</i>	<i>58</i>
2.3.5	<i>L1b LRM(FDM)/SAR/SARin Data Products MDS Record Structure</i>	<i>61</i>
2.3.6	<i>Monitoring MDS Record Structure</i>	<i>77</i>
2.3.6.1	LRM/TRK Monitoring MDS Record Structure.....	77
2.3.6.2	SAR Monitoring MDS Record Structure.....	81
2.3.6.3	SARIN Monitoring MDS Record Structure	83
2.3.6.4	CAL4 Monitoring MDS Record Structure	85
2.3.7	<i>Cal1 MDS Record Structures</i>	<i>87</i>
2.3.7.1	Cal1 LRM MDS Record Structures.....	87
2.3.7.2	Cal1 SAR MDS Record Structures	91
2.3.7.3	Cal1 SARIn MDS Record Structures	95
2.3.7.4	AUTO CAL1-SARIN MDS Record.....	101
2.3.8	<i>Cal2 MDS Record Structure.....</i>	<i>103</i>
2.3.8.1	Cal2 SAR MDS Record Structure.....	103



Advanced Computer Systems



Instrument Processing Facility L1b

Doc. No.: CS-RS-ACS-GS-5106
Issue: 4.0
Date: 10/12/2007
Page: 7

Deleted: 3.

Deleted: 2

Deleted: 3

Deleted: 07

2.3.8.2 Cal 2 SARIn MDS Record Structure..... 105

2.3.9 Cal3 MDS Record Structure..... 106

3 CRYOSAT LEVEL-1 PRODUCTS 112

3.1 FILE NAMES..... 113

 <p>Advanced Computer Systems</p>		<p><i>Instrument Processing Facility L1b</i></p> <p>Doc. No.: CS-RS-ACS-GS-5106 Issue: 4.0 Date: 10/12/2007 Page: 8</p>
--	---	--

- Deleted: 3.
- Deleted: 2
- Deleted: 3
- Deleted: 07

1 INTRODUCTION

This document contains the description of the format of all the Level-1 products generated inside the PDS for the Cryosat mission.

1.1 PURPOSE AND SCOPE

The purpose of the document is to define the product structure and the content of each Level-1 file generated in the PDS identifying for each data section and field the meaning and the format to be used for its representation.

1.2 DOCUMENT STRUCTURE

The document includes the following sections:

- | | |
|--|--|
| Section 1 - Introduction | The present section. |
| Section 2 - Level-1 General Format Description | This section gives the general description of the Level-1 products in terms of common organisation and format and the detailed description of the format for each file type. |
| Section 3 - Cryosat Level-1 Products | This section contains the product file name and the composition rules of the file name. |

 <p>Advanced Computer Systems</p>		<p><i>Instrument Processing Facility L1b</i></p> <p>Doc. No.: CS-RS-ACS-GS-5106 Issue: 4.0 Date: 10/12/2007 Page: 9</p>
--	---	---

- Deleted: 3.
- Deleted: 2
- Deleted: 3
- Deleted: 07

1.3 APPLICABLE & REFERENCE DOCUMENTS

1.3.1 Applicable Documents

Document Title	Identifier	Reference
Earth Explorer Ground Segment File Format Standard Issue 1.4 , 13 June 2003	CS-TN-ESA-GS-0154	[FMT-GUIDE]
Cryosat Ground Segment Master ICD Issue 4.0, April 2007	CS-ID-ESA-GS-0147	[MASTER-ICD]

- Formatted Table
- Formatted: Normal

1.3.2 Reference Documents

Document Title	Identifier	Reference
IPF1 Detailed Processing Model Issue 1.9, 02 August 2005	CS-TN-ACS-GS-5105	[IPF1-DPM]
Level 0 Products Specification Format Issue 1.5, 31 January 2003	CS-ID-ACS-GS-0119	[L0-FMT]
IEEE Standard for Binary Floating-Point Arithmetic. ANSI/IEEE Std 754-1985 Institute of Electrical and Electronics Engineers Issued 1985	IEEE-754	[IEEE]
Extensible Markup Language (XML) 1.0 (Second Edition) W3C Recommendation 6 October 2000	http://www.w3.org/TR/2000/REC-xml-20001006	[XML-GUIDE]
XML Schema Definition Language: W3C XML Schema Working Group and Schema Specifications	http://www.oasis-open.org/cover/schemas.html#W3CWorkingGroup	[XML-SCHEMA]
CCSDS Recommendation Time Code Formats Blue Book Issue 2.0, April 1990	CCSDS 301.0-B-2	[CCSDS-TIMEGUIDE]
CCSDS Recommendation Advanced Orbiting System, Networks and Data Links Architectural Specification Blue Book Issue 3.0, June 2001	CCSDS 701.0-B-3	[CCSDS-AOS]
Cryosat Master Interface Control Document Issue 1.1, 24 May 2002	CS-ID-ESA-GS-0147	[CS-ICD]
SIRAL User Manual Issue 3.0	SIRA-ASPI-MA-0228	[SIR-US]



Advanced Computer Systems



Instrument Processing Facility L1b

Doc. No.: CS-RS-ACS-GS-5106
Issue: 4.0
Date: 10/12/2007
Page: 10

Deleted: 3

Deleted: 2

Deleted: 3

Deleted: 07

1.4 ACRONYMS AND ABBREVIATIONS

ACS	Advanced Computer Systems S.p.A.
AGC	Automatic Gain Control
AIR	Azimuth Impulse Response
AISP	Annotated Instrument Source Packet
APID	Application Process Identifier
BER	Bit Error Rate
BLOB	Binary Large Object
CADU	Channel Access Data Unit
CAL	Calibration
CCSDS	Consultative Committee for Space Data Systems
CVCDU	Coded Virtual Channel Data Unit
DSR	Data Set Record
EO	Earth Observation
ESA	European Space Agency
FOS	Flight Operations Segment
FBR	Full Bit Rate
G/S	Ground Segment
HK/TM	Housekeeping/Telemetry data
ID	IDentifier
I/O	Input/Output
ISP	Instrument Source Packet
L1B	Level 1B
LRM	Low Rate Mode
MDS	Measurement Data Set
MJD	Modified Julian Day
MON	Monitoring
MPH	Main Product Header
PDS	Payload Data Segment
PSLR	Peak to Side Lobe Ratio
PSS-05	ESA Software Engineering Standard
rc	Radar Cycle
RIR	Range Impulse Response
SIRAL	Synthetic Interferometric Radar ALtimeter
SOW	Statement Of Work
SPH	Specific Product Header
TAI	International Atomic Time Reference
TBC	To Be Clarified
TBD	To Be Defined
TT&C	Tracking, Telemetry and Command
UTC	Universal Time Co-ordinates
VCID	Virtual Channel IDentifier
VCDU	Virtual Channel Data Unit
WGS84	World Geodetic System 1984
XML	eXtensible Markup Language



Advanced Computer Systems



Instrument Processing Facility L1b

Doc. No.: CS-RS-ACS-GS-5106
Issue: 4.0
Date: 10/12/2007
Page: 11

Deleted: 3

Deleted: 2

Deleted: 3

Deleted: 07

2 LEVEL-1 GENERAL FORMAT DESCRIPTION

The Level-1 products are derived from the SIRAL Instrument Level 0 data, applying the IPF1 processing algorithms defined in the IPF1 system of PDS.

IPF1 processing chains provide three types of Level1 products:

□ Level 1B

The L1B data is the main product output from the IPF1. In the case of SAR and SARIN modes of SIRAL, the L1B data are strongly compressed in size following the application of SAR/SARIN algorithms and multilooking for speckle reduction. Cal1 Cal2 and Cal3 products also belong to this class.

□ FBR

The Full Bit Rate (FBR) product is output at an intermediate stage before the L1B Processing is complete. This is the highest processing stage reached before information compression occurs. In particular the FBR data for SAR, SARIn, CAL3 modes still contain the echo data as complex numbers.

For LRM Mode the FBR product contains the individual PL echoes before any averaging process takes place.

Deleted: a

□ Monitoring

Monitoring data is a systematic product aimed to provide timely information on the health of the instrument. It consists of a set of instrument parameters which may be produced rapidly and routinely starting from LRM/TRK SIRAL data, SAR or SARIN data.

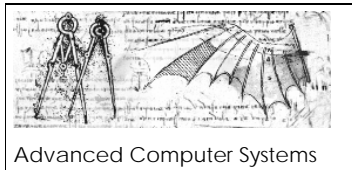

- Deleted: 3
- Deleted: 2
- Deleted: 3
- Deleted: 07

2.1 FILE STRUCTURE

The file structure of any file produced by the IPF1 system must follow the requirements of the [FMT-GUIDE] .

Each level-1 product is composed by two files:

- XML Header File
- Product File

The XML Header file is an auxiliary ASCII file that users can easily access for identifying the product without needs to look inside the Product File.

The Product File is the real product containing meaningful instrument's data and ASCII header used by ad hoc developed standard tools for inspecting the product's content. In order to use tools already developed for the ENVISAT mission, the product structure for Cryosat will follow the correspondent one of the ENVISAT products as far as possible.

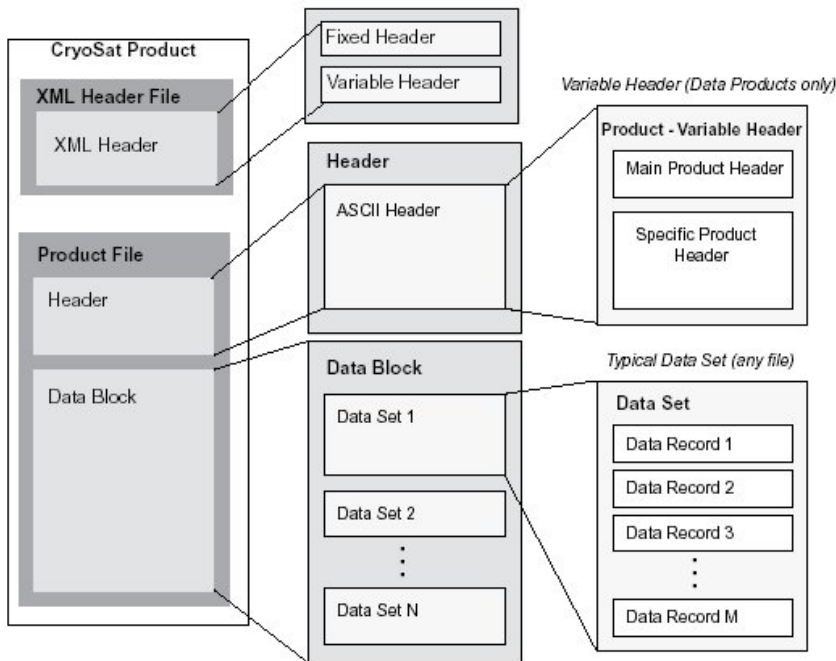

 <p>Advanced Computer Systems</p>		<p><i>Instrument Processing Facility L1b</i></p> <p>Doc. No.: CS-RS-ACS-GS-5106 Issue: 4.0 Date: 10/12/2007 Page: 13</p>
--	---	---

- Deleted: 3
- Deleted: 2
- Deleted: 3
- Deleted: 07

2.2 XML HEADER FILE

The XML Header file contains information identifying the product and easy to read as based on a standard syntax accessed by common tools available for visualising its content. The XML syntax has been chosen for the scope of the PDS.

The XML Header file is composed by:

- a Fixed Header
- a Variable Header

The Fixed Header (hereafter called Standard Cryosat Header) is the common header for all files managed into the PDS. That means it is applied to all files flowing amongst the sub-systems composing the PDS.

The Variable Header (hereafter called Product Header) is the header with format and content depending on the file type and kind of product.

2.2.1 Fixed Header (Cryosat Header)

The Standard Cryosat Header is completely ASCII and based on XML syntax and conventions proposed in [FMT-GUIDE].

The format and content of the Standard Cryosat Header is under ESA responsibility and it is specified in [FMT-GUIDE].

 <p>Advanced Computer Systems</p>		<p><i>Instrument Processing Facility L1b</i></p> <p>Doc. No.: CS-RS-ACS-GS-5106 Issue: 4.0 Date: 10/12/2007 Page: 14</p>
--	---	---

- Deleted: 3
- Deleted: 2
- Deleted: 3
- Deleted: 07

2.2.2 Variable Header (Product Header)

The Variable Header (hereafter called Product Header) for the Level 1 product is composed by:

- a XML Main Product Header (XML MPH)
- a XML Specific Product Header (XML SPH) which includes Reference Data Set Descriptors for external input files_one or more XML Specific Measurement Data Header (XML MDH) for the Data Sets of the Product

The XML MPH and XML SPH are derived from the correspondent headers (MPH and SPH) of the Product File, removing the unused fields and fields already reported in the Standard Cryosat Header.

Each header is completely ASCII and based on XML syntax and conventions proposed in the [FMT-GUIDE].

The following paragraphs describe the format and content of the XML MPH and XML SPH without overload of the XML format description.

2.2.2.1 XML Main Product Header (XML MPH)

Field #	Description	Units	Bytes	Format
	MPH	Tag		
	<i>Product Identification Info</i>			
#01	Product	Tag		
	Product File Name Note: the file name shall be without extension		62	See Section 3
#02	Proc_Stage_Code	Tag		
	Processing stage code identifier: RPRO = Reprocessing OFFL = Routine Operations NRT_ = Near Real Time TEST = Test LTA_ = Long Term Archive		4	4*uc
#03	Ref_Doc	Tag		
	Reference DFCB Document describing the product		23	CS-RS-ACS-GS-5106
	<i>Data Processing Information</i>			



Advanced Computer Systems



Instrument Processing Facility L1b

Doc. No.: CS-RS-ACS-GS-5106
 Issue: 4.0
 Date: 10/12/2007
 Page: 15

Deleted: 3

Deleted: 2

Deleted: 3

Deleted: 07

#04	Proc_Time	Tag		
	Processing Time (Product Generation Time)		30	UTC=yyyy-mm-ddThh:mm:ss.uuuuuu
#05	Software_Version	Tag		
	Processor Name and software version number.		14	ProcessorName/VV.rr
<i>Orbit Information</i>				
#06	Phase	Tag		
	Phase Code: If not used set to X		1	uc
#07	Cycle	Tag		
	Cycle number. If not used set to +000		4	%+04d
#08	Rel_Orbit	Tag		
	Relative Orbit Number at sensing start time. If not used set to +00000		6	%+06d
#09	Abs_Orbit	Tag		
	Absolute Orbit Number at sensing start time. If not used set to +00000		6	%+06d
#10	State_Vector_Time	Tag		
	UTC state vector time		30	UTC=yyyy-mm-ddThh:mm:ss.uuuuuu
#11	Delta_UT1	Tag		
	Universal Time Correction: DUT1 = UT1 – UTC If not used set to +.000000	s	8	%+08.6f
#12	X_Position	Tag		
	X position in Earth Fixed Reference If not used set to +0000000.000	m	12	%+012.3f
#13	Y_Position	Tag		
	Y position in Earth Fixed Reference If not used set to +0000000.000	m	12	%+012.3f
#14	Z_Position	Tag		
	Z position in Earth Fixed Reference If not used set to +0000000.000	m	12	%+012.3f
#15	X_Velocity	Tag		
	X velocity in Earth Fixed Reference If not used set to +0000.000000	m/s	12	%+012.6f
#16	Y_Velocity	Tag		
	Y velocity in Earth Fixed Reference	m/s	12	%+012.6f



Advanced Computer Systems



Instrument Processing Facility L1b

Doc. No.: CS-RS-ACS-GS-5106
 Issue: 4.0
 Date: 10/12/2007
 Page: 16

Deleted: 3.

Deleted: 2

Deleted: 3

Deleted: 07

	If not used set to +0000.000000			
#17	Z_Velocity	Tag		
	Z velocity in Earth Fixed Reference If not used set to +0000.000000	m/s	12	%+012.6f
#18	State_Vector_Source	Tag		
	Source of Orbit State Vector Record FP = FOS predicted DN = DORIS Level 0 navigator DP = DORIS precise orbit FR= FOS Restituted DI = DORIS Preliminary		2	2*uc
	<i>Product Confidence Data Information</i>			
#19	Product_Err	Tag		
	Product Error Flag 1 errors have been reported in the Product 0 no errors		1	uc
	<i>Product Size Information</i>			
#20	Tot_Size	Tag		
	Total Size of the Data Product	bytes	21	%021d

Table 2.2.2.1-1: XML Main Product Header Description



Advanced Computer Systems



Instrument Processing Facility L1b

Doc. No.: CS-RS-ACS-GS-5106
 Issue: 4.0
 Date: 10/12/2007
 Page: 17

Deleted: 3.

Deleted: 2

Deleted: 3

Deleted: 07

2.2.2.2 XML Specific Product Header (XML SPH)

Field #	Description	Units	Bytes	FORMAT
	SPH	tag		
<i>Product description and identification</i>				
#1	SPH_Descriptor	tag		
	Name describing the Specific Product Header		28	<i>ProductID SPECIFIC HEADER See Table 3-1</i>
<i>Product Time information</i>				
	Time_Information	tag		
#2	Start_Record_Time	tag		
	TAI of the first record in the Main MDS of this product		30	TAI=yyyy-mm-ddThh:mm:ss.uuuuuu
#3	Stop_Record_Time	tag		
	TAI of the last record in in the Main MDS of this product		30	TAI=yyyy-mm-ddThh:mm:ss.uuuuuu
<i>Product Orbit information</i>				
	Orbit_Information	Tag		
#4	ABS_Orbit_Start	Tag		
	Absolute Orbit Number at sensing start time.		6	%06d
#5	Rel_Time_ASC_Node_Start	Tag		
	Relative time since crossing ascending node time relative to start time of data sensing.	s	11	%011.6f
#6	ABS_Orbit_Stop	Tag		



Advanced Computer Systems



Instrument Processing Facility L1b

Doc. No.: CS-RS-ACS-GS-5106
 Issue: 4.0
 Date: 10/12/2007
 Page: 18

Deleted: 3.

Deleted: 2

Deleted: 3

Deleted: 07

	Absolute Orbit Number at sensing stop time.		6	%06d
#7	Rel_Time_ASC_Node_Stop	Tag		
	Time of the ascending node relative to stop time of data sensing. Relative time since crossing ascending node time relative to stop time of data sensing.	s	11	%011.6f
#8	Equator_Cross_Time	Tag		
	Time of equator crossing at the ascending node relative to the sensing start time.		30	UTC=yyyy-mm-ddThh:mm:ss.uuuuuu
#9	Equator_Cross_Long	Tag		
	Longitude of equator crossing at the ascending node relative to the sensing start time (positive East, 0 = Greenwich) referred to WGS84.	10-6 deg	11	%+011d
#10	Ascending_Flag	Tag		
	Orbit Orientation at the sensing start time A=Ascending D=Descending		1	uc
<i>Product Location Information</i>				
	Product_Location	tag		
#11	Start_Lat	tag		
	WGS84 latitude of the first record in the Main MDS (positive north)	10-6 deg	11	%+011d
#12	Start_Long	tag		
	WGS84 longitude of the first record in the Main MDS (positive East, 0 = Greenwich)	10-6 deg	11	%+011d
#13	Stop_Lat	tag		



Advanced Computer Systems



Instrument Processing Facility L1b

Doc. No.: CS-RS-ACS-GS-5106
 Issue: 4.0
 Date: 10/12/2007
 Page: 19

Deleted: 3.

Deleted: 2

Deleted: 3

Deleted: 07

	WGS84 latitude of the last record in the Main MDS (positive north)	10-6 deg	11	%+011d
#14	Stop_Long	tag		
	WGS84 longitude of the last record in the Main MDS (positive East, 0 = Greenwich)	10-6 deg	11	%+011d
<i>SIRAL Level 0 Quality information</i>				
	Level_0_Confidence_Data	tag		
#15	L0_Proc_Flag	tag		
	Processing errors significance flag 1 errors (percentage of errors greater than threshold) 0 no errors		1	uc
#16	L0_Processing_Quality	tag		
	Percentage of quality checks successfully passed during the SP processing (max allowed +10000)	10-2 %	6	%+06d
#17	L0_Proc_Thresh	tag		
	Minimum acceptable percentage of quality threshold that must be passed during SP processing (max allowed +10000)	10-2 %	6	%+06d
#18	L0_Gaps_Flag	tag		
	Flag to indicate gaps in input data 1 gaps 0 no gaps		1	uc
#19	L0_Gaps_Num	tag		
	Number of gaps detected during the SP processing		7	%07d
<i>SIRAL Instrument Configuration</i>				
	SIR_Instrument_Configuration	tag		
#20	Instrument_Identifier	tag	<u>1</u>	1*uc A (SIRAL Nominal) B (SIRAL Redundant)



Advanced Computer Systems



Instrument Processing Facility L1b

Doc. No.: CS-RS-ACS-GS-5106
 Issue: 4.0
 Date: 10/12/2007
 Page: 20

Deleted: 3

Deleted: 2

Deleted: 3

Deleted: 07

Deleted: 0

#21	SIR_Op_Mode	tag		
	SIRAL Operative Mode		10	10*uc LRM_____ SAR_____ SARIN_____ CAL1_LRM_____ CAL1_SAR_____ CAL1_SARIN_____ CAL2_SAR_____ CAL2_SARIN_____ CAL3_____ ACQ_____ TRK_CAL3_____ TRK_SARIN_____ TRK_SAR_____ CAL4_____
#22	SIR_Configuration	tag		
	SIRAL Rx Configuration		7	7*uc RX_1____ RX_2____ BOTH____ UNKNOWN
<i>Level 1 Surface Statistics</i>				
	Surface_Statistics	tag		
#23	Open_Ocean_Percent	tag		
	Percentage of input L1B records detected on open ocean or semi-enclosed seas	10-2 %	6	%+06d
#24	Close_Sea_Percent	tag		
	Percentage of input L1B records detected on close seas or lakes	10-2 %	6	%+06d
#25	Continent_Ice_Percent	tag		
	Percentage of input L1B records detected on continental ice	10-2 %	6	%+06d
#26	Land_Percent	tag		
	Percentage of input L1B records detected on land	10-2 %	6	%+06d
<i>SIRAL Level 1 Processing information</i>				

Deleted: 1

Deleted: 2

Deleted: 3

Deleted: 4

Deleted: 5



Advanced Computer Systems



Instrument Processing Facility L1b

Doc. No.: CS-RS-ACS-GS-5106
 Issue: 4.0
 Date: 10/12/2007
 Page: 21

Deleted: 3

Deleted: 2

Deleted: 3

Deleted: 07

	Level_1_Confidence_Data	tag		
#27	L1B_Prod_Status	tag		
	Complete/Incomplete Product Completion Flag (0 or 1). 1 if the Product as a duration shorter than the input Level 0		1	uc
#28	L1B_Proc_Flag	tag		
	Processing errors significance flag 1 errors (percentage of errors greater than threshold) 0 no errors		1	uc
#29	L1B_Processing_Quality	tag		
	Percentage of quality checks successfully passed during Level 1B processing (max allowed +10000)	10-2 %	6	%+06d
#30	L1B_Proc_Thresh	tag		
	Minimum acceptable percentage of quality threshold that must be passed during Level 1B processing (max allowed +10000)	10-2 %	6	%+06d
<i>Data Set Descriptors</i>				
	DSDs	tag		
	List_of_DSDs	tag		
	Data_Set_Descriptor	tag		
#31	Data_Set_Name	tag		
	Name of the Data Set		28	uc
#32	Data_Set_Type	tag		
	M for Measurement – R for Reference		1	uc
#33	File_Name	tag		
	Name of the reference file. Field is left empty for Measurement DSD		62	uc
#34	Data_Set_Offset	tag		
	Offset in bytes from the beginning of the DBL file. For reference DSDs the field is set to 0.	bytes	21	%+021d
#35	Data_Set_Size	tag		
	Size in bytes of the Measurement Data Set Record. For reference DSDs the field is set to 0.	bytes	21	%+021d

Deleted: 6

Deleted: 7

Deleted: 8

Deleted: 29

Deleted: 0

Deleted: 1

Deleted: 2

Deleted: 3

Deleted: 4



Advanced Computer Systems



Instrument Processing Facility L1b

Doc. No.: CS-RS-ACS-GS-5106
Issue: 4.0
Date: 10/12/2007
Page: 22

Deleted: 3

Deleted: 2

Deleted: 3

Deleted: 07

Deleted: 5

#36	Num_of_Records Number of Data Set Records. For reference DSDs the field is set to 0.	tag	11	%+011d
#37	Record_Size Record size in bytes. For reference DSDs the field is set to 0.	bytes	11	%+011d
#38	Byte_Order It describes the endianness of the data set 3210 → Big-endian 0123 → Little-endian For Reference DSDs the field is left empty	tag	4	%4c 3210 for Cryosat

Deleted: 6

Deleted: 7

Table 2.2.2.2-1: XML Specific Product Header description



Advanced Computer Systems



Instrument Processing Facility L1b

Doc. No.: CS-RS-ACS-GS-5106
Issue: 4.0
Date: 10/12/2007
Page: 23

Deleted: 3.

Deleted: 2

Deleted: 3

Deleted: 07

2.3 PRODUCT FILES

The Product File structure will follow the one defined for the ENVISAT level-0 products as much as possible.

Formatted: None

As shown in figure 2.3-1, each product file is composed by:

- Main Product Header (MPH)
- Specific Product Header (SPH)
- Data Sets

Formatted: None, Indent: Left: 0.63 cm, Hanging: 0.63 cm

Formatted: None

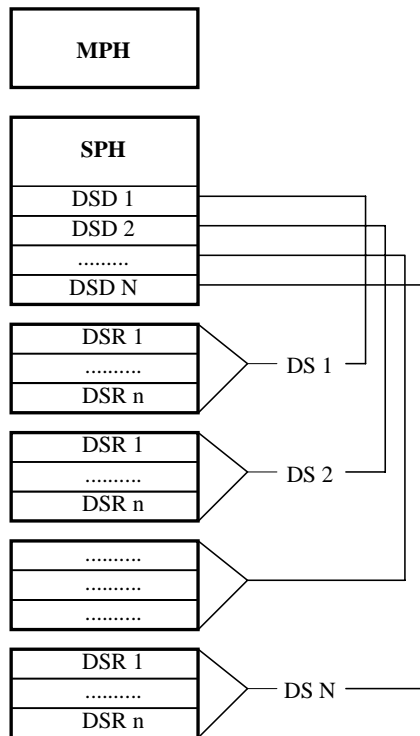

Figure 2.3-1: Generalised Product Structure

The MPH and SPH blocks are ASCII and following the current syntax for any composing field:

FieldName = value <units>

The Data Sets are completely binary and contains one or more Data Set Records each. According to the following Products definitions the maximum number of DS in a product is two.



Advanced Computer Systems



Instrument Processing Facility L1b

Doc. No.: CS-RS-ACS-GS-5106
 Issue: 4.0
 Date: 10/12/2007
 Page: 24

Deleted: 3

Deleted: 2

Deleted: 3

Deleted: 07

2.3.1 Main Product Header (MPH)

Formatted: None

Field #	Description	Units	Bytes	Format	
<i>Product Identification Info</i>					
#01	PRODUCT=	keyword	8		
	quotation mark (")		1	uc	
	Product File Name It is left justified with trailer blanks		62	See 3.1	
	quotation mark (")		1	uc	
	newline character	terminator	1		
#02	PROC_STAGE=	keyword	11	11*uc	
	Processing stage code: N = Near-Real Time T = Test O = OFF Line (Systematic) R = Reprocessing L = Long Term Archive		1		
	newline character	terminator	1		
	#03	REF_DOC=	keyword	8	8*uc
		quotation mark (")		1	uc
Reference DFCB Document describing the product			23	23*uc	
quotation mark (")			1	uc	
newline character	terminator	1			
#04	Spare (blank characters)		40	40*uc	
	newline character	terminator	1	uc	
<i>Data Processing Information</i>					
#05	ACQUISITION_STATION=	keyword	20	20*uc	
	quotation mark (")		1	uc	
	Acquisition Station ID Filled by blanks		20	Kiruna	
	quotation mark (")		1	uc	
	newline character	terminator	1		
#06	PROC_CENTER=	keyword	12	12*uc	
	quotation mark (")		1	uc	
	Processing Center ID code		6	PDS	
	quotation mark (")		1	uc	
	newline character	terminator	1		



Advanced Computer Systems



Instrument Processing Facility L1b

Doc. No.: CS-RS-ACS-GS-5106
 Issue: 4.0
 Date: 10/12/2007
 Page: 25

Deleted: 3

Deleted: 2

Deleted: 3

Deleted: 07

#07	PROC_TIME=	keyword	10	10*uc
	quotation mark (")		1	uc
	Processing Time (Product Generation Time)	UTC	27	dd-MMM-yyyy hh:mm:ss.uuuuuu
	quotation mark (")		1	uc
	newline character	terminator	1	
#08	SOFTWARE_VER=	keyword	13	13*uc
	quotation mark (")		1	uc
	Processor name, up to 8 characters, and software version number followed by trailer blanks if any. If not used set to blanks		14	14*uc ProcessorName/VV.rr
	quotation mark (")		1	uc
	newline character	terminator	1	
#09	Spare (blank characters)		40	40*uc
	newline character	terminator	1	uc
<i>Information on Time of Data</i>				
#10	SENSING_START=	keyword	14	14*uc
	quotation mark (")		1	uc
	UTC start time of data sensing. This is the UTC start time of the Input Level 0 Product. If not used set to 27 blanks	UTC	27	dd-MMM-yyyy hh:mm:ss.uuuuuu
	quotation mark (")		1	uc
	newline character	terminator	1	
#11	SENSING_STOP=	keyword	13	13*uc
	quotation mark (")		1	uc
	UTC stop time of data sensing. This is the UTC stop time of the Input Level 0 Product. If not used set to 27 blanks	UTC	27	dd-MMM-yyyy hh:mm:ss.uuuuuu
	quotation mark (")		1	uc
	newline character	terminator	1	
#12	Spare (blank characters)		40	40*uc
	newline character	terminator	1	uc
<i>Orbit Information</i>				
#13	PHASE=	keyword	6	6*uc
	Phase Code: phase letter (A, B, ...) If not used set to X		1	
	newline character	terminator	1	uc



Advanced Computer Systems



Instrument Processing Facility L1b

Doc. No.: CS-RS-ACS-GS-5106
 Issue: 4.0
 Date: 10/12/2007
 Page: 26

Deleted: 3.

Deleted: 2

Deleted: 3

Deleted: 07

#14	CYCLE=	keyword	6	6*uc
	Cycle number. If not used set to +000		4	%+04d
	newline character	terminator	1	uc
#15	REL_ORBIT=	keyword	10	10*uc
	Relative Orbit Number at sensing start time. If not used set to +00000		6	%+06d
	newline character	terminator	1	uc
#16	ABS_ORBIT=	keyword	10	10*uc
	Absolute Orbit Number at sensing start time. If not used set to +00000		6	%+06d
	newline character	terminator	1	uc
#17	STATE_VECTOR_TIME=	keyword	18	18*uc
	quotation mark (")		1	uc
	UTC state vector time It is filled properly in case of usage of FOS Predicted Orbit information otherwise it shall be set to 27 blanks	UTC	27	dd- <i>MMM</i> - <i>yyyy</i> hh:mm:ss. <i>uuuuuu</i>
	quotation mark (")		1	uc
	newline character	terminator	1	
#18	DELTA_UT1=	keyword	10	10*uc
	Universal Time Correction: DUT1 = UT1 – UTC Not used for Cryosat. It shall be set to +.000000	s	8	%+08.6f
	<s>	units	3	3*uc
	newline character	terminator	1	
#19	X_POSITION=	keyword	11	11*uc
	X position in Earth Fixed Reference. If not used set to +0000000.000	m	12	%+012.3f
	<m>	units	3	3*uc
	newline character	terminator	1	
#20	Y_POSITION=	keyword	11	11*uc
	Y position in Earth Fixed Reference. If not used set to +0000000.000	m	12	%+012.3f
	<m>	units	3	3*uc
	newline character	terminator	1	



Advanced Computer Systems



Instrument Processing Facility L1b

Doc. No.: CS-RS-ACS-GS-5106
 Issue: 4.0
 Date: 10/12/2007
 Page: 27

Deleted: 3

Deleted: 2

Deleted: 3

Deleted: 07

#21	Z_POSITION=	keyword	11	11*uc
	Z position in Earth Fixed Reference. If not used set to +0000000.000	m	12	%+012.3f
	<m>	units	3	3*uc
	newline character	terminator	1	
#22	X_VELOCITY=	keyword	11	11*uc
	X velocity in Earth Fixed Reference. If not used set to +0000.000000	m/s	12	%+012.6f
	<m/s>	units	5	5*uc
	newline character	terminator	1	
#23	Y_VELOCITY=	keyword	11	11*uc
	Y velocity in Earth Fixed Reference. If not used set to +0000.000000	m/s	12	%+012.6f
	<m/s>	units	5	5*uc
	newline character	terminator	1	
#24	Z_VELOCITY=	keyword	11	11*uc
	Z velocity in Earth Fixed Reference. If not used set to +0000.000000	m/s	12	%+012.6f
	<m/s>	units	5	5*uc
	newline character	terminator	1	
#25	VECTOR_SOURCE=	keyword	14	14*uc
	quotation mark (")		1	uc
	Source of Orbit State Vector Record FP = FOS predicted DN = DORIS Level 0 navigator DP = DORIS precise orbit FR = FOS Restituted DI = DORIS Preliminary		2	2*uc
	quotation mark (")		1	uc
	newline character	terminator	1	
#26	Spare (blank characters)		40	40*uc
	newline character	terminator	1	uc
<i>SBT to UTC conversion Information</i>				
#27	UTC_SBT_TIME=	keyword	13	13*uc
	quotation mark (")		1	uc



Advanced Computer Systems



Instrument Processing Facility L1b

Doc. No.: CS-RS-ACS-GS-5106
 Issue: 4.0
 Date: 10/12/2007
 Page: 28

Deleted: 3

Deleted: 2

Deleted: 3

Deleted: 07

	Not used and set to 27 blanks		27	\$
	quotation mark (")		1	uc
	newline character	terminator	1	uc
#28	SAT_BINARY_TIME=	keyword	16	16*uc
	Satellite Binary Time Not used for Cryosat and it shall be set to zeros		11	+0000000000
	newline character	terminator	1	uc
#29	CLOCK_STEP =	keyword	11	11*uc
	Clock Step Not used for Cryosat and it shall be set to zeros		11	+0000000000
	<ps>	units	4	4*uc
	newline character	terminator	1	uc
#30	Spare (blank characters)		32	32*uc
	newline character	terminator	1	uc
<i>Leap Second Information</i>				
#31	LEAP.UTC=	keyword	9	9*uc
	quotation mark (")		1	uc
	UTC Time of the occurrence of the leap second. If a leap second occurred in the product window the field is set by a devoted function in the CFI EXPLORER_ORBIT library (see [EXPL_ORB-SUM] for details), otherwise it is set to 27 blanks. It corresponds to the time after the Leap Second occurrence (i.e. midnight of the day after the leap second)		27	dd-MMM-yyyy hh:mm:ss.uuuuuu
	quotation mark (")		1	uc
	newline character	terminator	1	uc
#32	LEAP_SIGN=	keyword	10	10*uc
	Leap second sign If a leap second occurred in the product window the field is set to the expected value by a devoted function in the CFI EXPLORER_ORBIT library (see [EXPL_ORB-SUM] for details), otherwise it is set to +000.	s	4	%+04d
	newline character	terminator	1	uc
#33	LEAP_ERR=	keyword	9	9*uc



Advanced Computer Systems



Instrument Processing Facility L1b

Doc. No.: CS-RS-ACS-GS-5106
 Issue: 4.0
 Date: 10/12/2007
 Page: 29

Deleted: 3.

Deleted: 2

Deleted: 3

Deleted: 07

	Leap second error flag. This field is always set to 0 considering that CRYOSAT products have true UTC times		1	uc
	newline character	terminator	1	uc
#34	Spare (blank characters)		40	40*uc
	newline character	terminator	1	uc
<i>Product Confidence Data Information</i>				
#35	PRODUCT_ERR=	keyword	12	12*uc
	Product Error Flag set to 1 if errors have been reported in the product		1	uc
	newline character	terminator	1	uc
<i>Product Size Information</i>				
#36	TOT_SIZE=	keyword	9	9*uc
	Total size of the product	bytes	21	%+021d
	<bytes>	units	7	7*uc
	newline character	terminator	1	Uc
#37	SPH_SIZE=	keyword	9	9*uc
	Length of the SPH	bytes	11	%+011d
	<bytes>	units	7	7*uc
	newline character	terminator	1	Uc
#38	NUM_DSD=	keyword	8	8*uc
	Number of Data Set Descriptors, including spares and all other types of DSDs		11	%+011d
	newline character	terminator	1	Uc
#39	DSD_SIZE=	keyword	9	9*uc
	Length of each DSD	bytes	11	%+011d
	<bytes>	units	7	7*uc
	newline character	terminator	1	Uc
#40	NUM_DATA_SETS=	keyword	14	14*uc
	Number of attached Data Sets (note that not all the DSDs have a DS attached)		11	%+011d
	newline character	terminator	1	Uc
#41	CRC=	keyword	4	4*uc
	Cyclic Redundancy Code computed as overall value of all records of the Measurement Data Set. If not computed it shall be set to -00001		6	%+06d
	newline character	terminator	1	Uc

 <p>Advanced Computer Systems</p>		<p><i>Instrument Processing Facility L1b</i></p> <p>Doc. No.: CS-RS-ACS-GS-5106 Issue: 4.0 Date: 10/12/2007 Page: 30</p>
--	---	---

- Deleted: 3
- Deleted: 2
- Deleted: 3
- Deleted: 07

#42	Spare (blank characters)		29	29*uc
	newline character	terminator	1	uc
	TOTAL		1247	

Table 2.3.1-1 Product MPH Description

Formatted: None



Advanced Computer Systems



Instrument Processing Facility L1b

Doc. No.: CS-RS-ACS-GS-5106
 Issue: 4.0
 Date: 10/12/2007
 Page: 31

Deleted: 3.

Deleted: 2

Deleted: 3

Deleted: 07

2.3.2 Specific Product Header (SPH)

The Specific Product Header is an ASCII header. A general structure valid for all SIRAL IPF1 products is proposed. The proposed SPH structure is as follows.

Field #	Description	Units	Bytes	Data Type
<i>Product description and identification</i>				
#1	SPH_DESCRIPTOR=	keyword	15	15*uc
	quotation mark (")		1	uc
	ASCII string describing the product		28	28*uc Product ID SPECIFIC HEADER See Product ID in table 3-1
	quotation mark (")		1	uc
	newline character	terminator	1	uc
<i>Product Time information</i>				
#2	START_RECORD_TAI_TIME=	keyword	22	22*uc
	quotation mark (")		1	uc
	TAI of the first record in the Main MDS of this product	TAI	27	dd-MMM-yyyy hh:mm:ss.uuuuuu
	quotation mark (")		1	uc
	newline character	terminator	1	uc
#3	STOP_RECORD_TAI_TIME=	keyword	21	21*uc
	quotation mark (")		1	uc
	TAI of the last record in in the Main MDS of this product	TAI	27	dd-MMM-yyyy hh:mm:ss.uuuuuu
	quotation mark (")		1	uc
	newline character	terminator	1	uc
<i>Product Orbit Information</i>				
#4	ABS_ORBIT_START=	Keyword	16	16*uc
	Absolute Orbit Number at Product Start Time		6	%06d
	newline character	terminator	1	uc



Advanced Computer Systems



Instrument Processing Facility L1b

Doc. No.: CS-RS-ACS-GS-5106
 Issue: 4.0
 Date: 10/12/2007
 Page: 32

Deleted: 3.

Deleted: 2

Deleted: 3

Deleted: 07

#5	REL_TIME_ASC_NODE_START =	Keyword	24	24*uc
	Relative time since crossing ascending node time relative to start time of data sensing	s	11	%011.6f
	<s>	units	3	3*uc
	Newline character	terminator	1	Uc
#6	ABS_ORBIT_STOP=	Keyword	15	15*uc
	Absolute Orbit Number at Product Stop Time		6	%06d
	Newline character	terminator	1	uc
#7	REL_TIME_ASC_NODE_STOP=	Keyword	23	23*uc
	Relative time since crossing ascending node time relative to stop time of data sensing	s	11	%011.6f
	<s>	units	3	3*uc
	Newline character	terminator	1	uc
#8	EQUATOR_CROSS_TIME_UTC=	Keyword	23	23*uc
	Quotation mark("")		1	uc
	Time of Equator crossing at the ascending node of the sensing start time	UTC	27	dd-MMM-yyyy hh:mm:ss.uuuuuu
	Quotation mark ("")		1	uc
	Newline character	terminator	1	uc
#9	EQUATOR_CROSS_LONG=	Keyword	19	19*uc
	Longitude of Equator Crossing at the ascending node of the sensing start time (positive East, 0 = Greenwich) referred to WGS84	s	11	%+011d
	<10-6degE>	units	10	10*uc
	Newline character	terminator	1	uc
#10	ASCENDING_FLAG=	Keyword	15	15*uc
	Orbit Orientation at the sensing start time A= Ascending D= Descending		1	uc
	Newline character	terminator	1	uc
	<i>Product Location Information</i>			
#11	START_LAT=	keyword	10	10*uc
	WGS84 latitude of the first record in the Main MDS (positive north)	[10-6 deg]	11	%+011d



Advanced Computer Systems



Instrument Processing Facility L1b

Doc. No.: CS-RS-ACS-GS-5106
 Issue: 4.0
 Date: 10/12/2007
 Page: 33

Deleted: 3.

Deleted: 2

Deleted: 3

Deleted: 07

	<10-6degN>	units	10	10*uc
	newline character	terminator	1	uc
#12	START_LONG=	keyword	11	11*uc
	WGS84 longitude of the first record in the Main MDS (positive East, 0 = Greenwich)	[10-6 deg]	11	%+011d
	<10-6degE>	units	10	10*uc
	newline character	terminator	1	uc
#13	STOP_LAT=	keyword	9	9*uc
	WGS84 latitude of the last record in the Main MDS (positive north)	[10-6 deg]	11	%+011d
	<10-6degN>	units	10	10*uc
	newline character	terminator	1	uc
#14	STOP_LONG=	keyword	10	10*uc
	WGS84 longitude of the last record in the Main MDS (positive East, 0 = Greenwich)	[10-6 deg]	11	%+011d
	<10-6degE>	units	10	10*uc
	newline character	terminator	1	uc
#15	Spare (blank characters)	ascii	50	50*uc
	newline character	terminator	1	uc
<i>Level 0 Quality information</i>				
#16	LO_PROC_FLAG=	keyword	13	13*uc
	Processing errors significance flag (1 or 0).			
	1 if the percentage of SIRAL packets free of processing errors is less than the acceptable threshold		1	uc
	newline character	terminator	1	uc
#17	LO_PROCESSING_QUALITY=	keyword	22	22*uc
	Percentage of quality checks successfully passed during the SP processing (max allowed +10000)	[10-2 %]	6	%+06d
	<10-2%>	units	7	7*uc
	newline character	terminator	1	uc
#18	LO_PROC_THRESH=	keyword	15	15*uc
	Minimum acceptable percentage of quality threshold that must be passed during SP processing (max allowed +10000)	[10-2 %]	6	%+06d



Advanced Computer Systems



Instrument Processing Facility L1b

Doc. No.: CS-RS-ACS-GS-5106
Issue: 4.0
Date: 10/12/2007
Page: 34

Deleted: 3.

Deleted: 2

Deleted: 3

Deleted: 07

	<10-2%>	units	7	7*uc	
	newline character	terminator	1	uc	
#19	LO_GAPS_FLAG=	keyword	13	13*uc	
	Gaps significance flag (1 or 0). 1 if gaps (either caused by extraction or alignment failures) were detected during the SP processing		1	uc	
	newline character	terminator	1	uc	
#20	LO_GAPS_NUM=	keyword	12	12*uc	
	Number of gaps detected during the SP processing (no gaps indicated as +0000000)		8	%+08d	
	newline character	terminator	1	uc	
#21	Spare (blank characters)	ascii	37	37*uc	
	newline character	terminator	1	uc	

Deleted: 50

Deleted: 50



Advanced Computer Systems



Instrument Processing Facility L1b

Doc. No.: CS-RS-ACS-GS-5106
 Issue: 4.0
 Date: 10/12/2007
 Page: 35

Deleted: 3

Deleted: 2

Deleted: 3

Deleted: 07

SIRAL Instrument Configuration				
#22	INSTR_ID=	keyword	9	9*uc
	quotation mark (")		1	uc
	Instrument identifier		1	1*uc A = SIRAL Nominal B = SIRAL Redundant
	quotation mark (")		1	uc
	newline character	terminator	1	uc
	#23	SIR_OP_MODE=	keyword	12
	quotation mark (")		1	uc
	SIRAL Operative Mode:		10	10*uc
	LRM\$\$\$\$\$			
	SAR\$\$\$\$\$			
	SARIN\$\$\$\$\$			
	CAL1_LRM\$\$			
	CAL1_SAR\$\$			
	CAL1_SARIN			
	CAL2_SAR\$\$			
	CAL2_SARIN			
	CAL3\$\$\$\$\$			
	ACQ\$\$\$\$\$			
	TRK_CAL3\$\$			
	TRK_SAR\$\$\$			
	TRK_SARIN\$			
	CAL4\$\$\$\$\$			
	(strings shorter than 10 are filled in with blanks \$)			
	quotation mark (")		1	uc
	Newline character	terminator	1	uc
#24	SIR_CONFIGURATION=	keyword	18	17*uc
	quotation mark (")		1	uc

Formatted Table

Deleted: 2

Deleted: 3



Advanced Computer Systems



Instrument Processing Facility L1b

Doc. No.: CS-RS-ACS-GS-5106
 Issue: 4.0
 Date: 10/12/2007
 Page: 36

Deleted: 3

Deleted: 2

Deleted: 3

Deleted: 07

SIRAL Configuration:		7	7*uc
RX_1\$\$\$			
RX_2\$\$\$			
BOTH\$\$\$			
UNKNOWN			
(strings shorter than 7 are filled in with blanks)			
quotation mark (")		1	uc
Newline character		terminator	1 uc
<i>Surface ID Statistics</i>			
#25	OPEN_OCEAN_PERCENT=	keyword	19 19*uc
	Percentage of records detected on open ocean or semi-enclosed seas	[10-2 %]	6 %+06d
	<10-2%>	units	7 7*uc
	Newline character	terminator	1 uc
#26	CLOSE_SEA_PERCENT=	keyword	18 18*uc
	Percentage of records detected on close seas or lakes	[10-2 %]	6 %+06d
	<10-2%>	units	7 7*uc
	Newline character	terminator	1 Uc
#27	CONTINENT_ICE_PERCENT=	keyword	22 22*uc
	Percentage of records detected on continental ice	[10-2 %]	6 %+06d
	<10-2%>	units	7 7*uc
	Newline character	terminator	1 Uc
#28	LAND_PERCENT=	keyword	13 13*uc
	Percentage of records detected on land	[10-2 %]	6 %+06d
	<10-2%>	units	7 7*uc
	Newline character	terminator	1 Uc
#29	Spare (blank characters)	ascii	50 50*uc
	newline character	terminator	1 uc
<i>Level 1 Processing information</i>			
#30	L1B_PROD_STATUS=	keyword	16 16*uc

Deleted: 4

Deleted: 5

Deleted: 6

Deleted: 7

Deleted: 8

Deleted: 29



Advanced Computer Systems



Instrument Processing Facility L1b

Doc. No.: CS-RS-ACS-GS-5106
 Issue: 4.0
 Date: 10/12/2007
 Page: 37

Deleted: 3

Deleted: 2

Deleted: 3

Deleted: 07

	Complete/Incomplete Product Completion Flag (0 or 1). 1 if the Product as a duration shorter than the input Level 0		1	uc	
	newline character	terminator	1	uc	
#31	L1B_PROC_FLAG=	keyword	14	14*uc	Deleted: 0
	Processing errors significance flag (1 or 0). 1 if the percentage of DSR free of processing errors is less than the acceptable threshold		1	uc	
	newline character	terminator	1	uc	
#32	L1B_PROCESSING_QUALITY=	keyword	23	23*uc	Deleted: 1
	Percentage of quality checks successfully passed during Level 1B processing (max allowed +10000)	[10-2 %]	6	%+06d	
	<10-2%>	units	7	7*uc	
	newline character	terminator	1	uc	
#33	L1B_PROC_THRESH=	keyword	16	16*uc	Deleted: 2
	Minimum acceptable percentage of quality threshold that must be passed during Level 1B processing (max allowed +10000)	[10-2 %]	6	%+06d	
	<10-2%>	units	7	7*uc	
	newline character	terminator	1	uc	
#34	Spare (blank characters)	ascii	50	50*uc	Deleted: 3
	newline character	terminator	1	uc	
	TOTAL				

DSD Section

Table 2.3.2-1 Product SPH Description

The DSD Section shall actually be divided in two principal sections, Measurement DSD, indicated as DSD (M) and Reference DSD, indicated as DSD (R). The general structure of a DSD is shown in table 2.3.2-2. The size of a DSD is 280 bytes.



Advanced Computer Systems



Instrument Processing Facility L1b

Doc. No.: CS-RS-ACS-GS-5106
 Issue: 4.0
 Date: 10/12/2007
 Page: 38

- Deleted: 3.
- Deleted: 2
- Deleted: 3
- Deleted: 07
- Formatted: Keep with next

#N	<i>DSD</i>			
#N.1	DS_NAME=	keyword	8	8*uc
	quotation mark		1	uc
	Name describing the Data Set		28	28*uc
	quotation mark		1	uc
	newline character	terminator	1	uc
#N.2	DS_TYPE=	keyword	8	8*uc
	Type of Data Set. It can be: M = Measurement R = Reference		1	uc
	newline character	terminator	1	uc
	<i>External product reference</i>			
#N.3	FILENAME=	keyword	9	9*uc
	quotation mark		1	uc
	Name of the Reference File. Used if DS_TYPE is set to R. It is left justified with trailer blanks. The file name includes the extension. If not used it is set to 62 blanks.		62	62*uc
	quotation mark		1	uc
	newline character	terminator	1	uc
	<i>Position and size of DS</i>			
#N.4	DS_OFFSET=	keyword	10	10*uc
	Length in bytes of MPH + SPH (including DSDs) + DS size of previous Data Set (if any).	byte	21	%+021d
	<bytes>	units	7	7*uc
	newline character	terminator	1	uc
#N.5	DS_SIZE=	keyword	8	8*uc
	Length in bytes of the attached Data Set Used if DS_TYPE is set to M If not used set to 0	byte	21	%+021d
	<bytes>	units	7	7*uc
	newline character	terminator	1	uc

- Deleted: 3.
- Deleted: 2
- Deleted: 3
- Deleted: 07
- Formatted: Keep with next

<i>Number and length of DSRs</i>				
#N.6	NUM_DSR=	keyword	8	8*uc
	Number of Data Set Records		11	%+011d
	newline character	terminator	1	uc
#N.7	DSR_SIZE=	keyword	9	9*uc
	Length in bytes of the Data Set Record If not used set to +0 If variable set to -1	byte	11	%+011d
	<bytes>	units	7	7*uc
	newline character	terminator	1	uc
#N.8	Spare	ascii	32	32*uc
	newline character	terminator	1	uc

Table 2.3.2-2 Generic DSD Description

A variable number of DSDs will compose the SPH. Variability in fact depends most on the number of auxiliary files and input Level 0 files effectively used to generate the product.

For convenience Measurement DSDs (1 or more) should appear first in the list, followed by all the needed Reference DSDs.

The effective size of the SPH in number of bytes is defined in field #37 SPH_SIZE of the MPH.

The total number of DSD Descriptors is defined in field #38 of the MPH.

The number of Measurement DSDs is defined in field 40 of the MPH.

For the Measurement Data Sets the DSD 1 (M) may have the following options for the DS_NAME:

<i>DS_NAME for DSD 1 (M)</i>
SIR_FBR_SAR
SIR_FBR_SARIN
SIR_FBR_LRM
SIR_FBR_FDM



Advanced Computer Systems



Instrument Processing Facility L1b

Doc. No.: CS-RS-ACS-GS-5106
Issue: 4.0
Date: 10/12/2007
Page: 40

Deleted: 3

Deleted: 2

Deleted: 3

Deleted: 07

SIR_L1B_SAR
SIR_L1B_SARIN
SIR_L1B_LRM
SIR_L1B_FDM
SIR_FBR_CAL3
SIR_CAL1_LRM
SIR_CAL1_SAR
SIR_CAL1_SARIN
SIR_COMPLEX_CAL1_SARIN
SIR_CAL2_SAR
SIR_CAL2_SARIN
SIR_L1B_CAL3
SIR_LRM_OM
SIR_SAR_OM
SIR_SIN_OM
SIR_CAL4_OM

Table 2.3.2-3 DS Names for Measurement Data Sets DSD 1

The DSD 2 (M) may have the following options for the DS_NAME:

<i>DS_NAME for DSD 2 (M)</i>
SIR_CAL1_LRM_INTERP_COR
SIR_CAL1_SAR_INTERP_COR
SIR_CAL1_SIN_INTERP_COR

Table 2.3.2-4 DS Names for Measurement Data Sets DSD 2

 <p>Advanced Computer Systems</p>		<p><i>Instrument Processing Facility L1b</i></p> <p>Doc. No.: CS-RS-ACS-GS-5106 Issue: 4.0 Date: 10/12/2007 Page: 41</p>
--	---	---

- Deleted: 3
- Deleted: 2
- Deleted: 3
- Deleted: 07
- Deleted: s

For the Reference DSDs the possible DS_NAME are hereafter listed. For a given DS_NAME one or more Reference DSDs may be in the final layout of the DSD if more than one file was used to generate the product. Identification of the specific file will be possible through the field #N.3 FILENAME.

<i>DS_NAME for DSD (R)</i>	
CONSTANTS_FILE	Constants File
PROC_CONFIG_PARAMS_FILE	Processor Configuration Parameters File
SIRAL_LEVEL_0_FILE	SIRAL LEVEL 0 File from which the product was created
SCENARIO_FILE	Orbit Scenario File
ORBIT_FILE	Orbit Data File
STAR_TRACKER_LEVEL_0_FILE	Star Tracker Level 0 File
DORIS_USO_DRIFT_FILE	DORIS USO Drift File
FOS_PLATFORM_DATA_FILE	FOS Platform Data File
FOS_HK_TM_FILE	FOS Sorted HouseKeeping Telemetries File
IPF_RA_DATABASE_FILE	Instrument Characterisation Data File
CALIBRATION_TYPE_1_FILE	File Product containing CAL_1 corrections
CALIBRATION_TYPE_2_FILE	File Product containing CAL_2 corrections
CALIBRATION_TYPE_3_FILE	File Product containing the CAL_3 corrections
SIR_COMPLEX_CAL1_SARIN	File Product containing Complex CAL1 SARIN corrections
OCEAN_TIDE_FILE	File for Ocean Tide
TIDAL_LOADING_FILE	File for Tidal Loading
EARTH_TIDE_FILE	CartWright File
POLE_TIDE_FILE	Pole Location Data File
SURFACE_TYPE_FILE	Surface Type Map File
S1S2_PRESSURE_00H_MAP	Climatology Pressure Grids for each month at 00 hh.
S1S2_PRESSURE_06H_MAP	Climatology Pressure Grids for each month at 06 hh.
S1S2_PRESSURE_12H_MAP	Climatology Pressure Grids for each month at 12 hh.
S1S2_PRESSURE_18H_MAP	Climatology Pressure Grids for each month at 18 hh.
S1_TIDE_AMPLITUDE_MAP	S1 tide grid of monthly mean of global amplitude
S2_TIDE_AMPLITUDE_MAP	S2 tide grid of monthly mean of global amplitude
S1_TIDE_PHASE_MAP	S1 tide grid of monthly mean of global phase
S2_TIDE_PHASE_MAP	S2 tide grid of monthly mean of global phase
MODIFIED_DIP_MAP_FILE	Modified Dip Map File used for BENT Ionospheric Correction
IONO_COEFFICIENTS_FILE	Ionospheric Coefficients file used for BENT Ionospheric Correction
SAI_FILE	Solar Activity Index File used for BENT Ionospheric Correction
GPS_IONO_MAP	GPS Ionospheric Map Data
SURFACE_PRESSURE_FILE	Surface Pressure File for Meteo Correction
MEAN_PRESSURE_FILE	Mean Pressure File for Meteo Correction
WET_TROPOSPHERE_FILE	Wet Troposphere File for Meteo Correction
DRY_ROPOSPHERE_FILE	Dry Troposphere File for Meteo Correction
U_WIND_FILE	U Wind component File for Meteo Correction
V_WIND_FILE	V Wind component File for Meteo Correction
METEO_GRID_DEF_FILE	Meteo Grid Definition File

Deleted: a

Table 2.3.2-5 DS Names for Reference DSDs

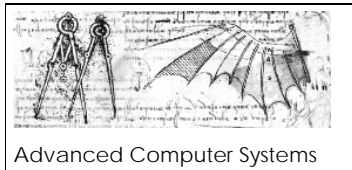

Instrument Processing Facility L1b

Doc. No.: CS-RS-ACS-GS-5106
Issue: 4.0
Date: 10/12/2007
Page: 42

Deleted: 3.

Deleted: 2

Deleted: 3

Deleted: 07

2.3.3 FBR LRM(FDM¹)/SAR/SARin MDS Record Structure

The structure of this MDS is as follows:

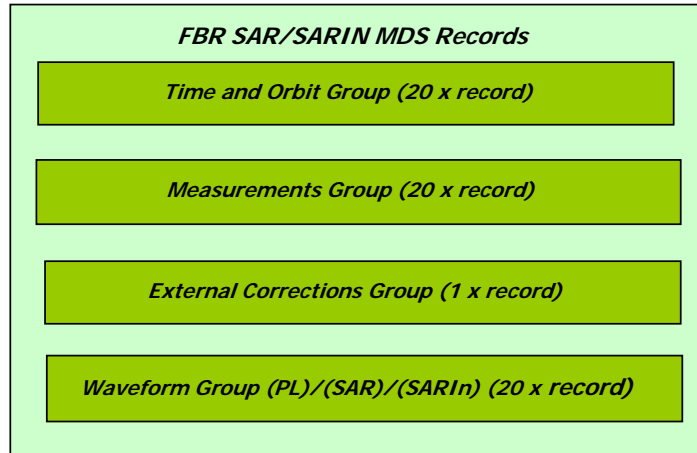

The (PL) (SAR) and (SARin) waveform group are exclusive one of the other while all the previous groups are in common.

¹ Fast Delivery Ocean (FDM) product is produced for LRM mode data only and is run as soon as possible after acquisition. The FBR and L1B FDM products have the same record structure as LRM



Advanced Computer Systems



Instrument Processing Facility L1b

Doc. No.: CS-RS-ACS-GS-5106
 Issue: 4.0
 Date: 10/12/2007
 Page: 43

Deleted: 3.

Deleted: 2

Deleted: 3

Deleted: 07

Field	Description	Units	Bytes	Format
Mode - Time and Orbit Group				
1	Data Record Time (MDSR Time Stamp)	TAI	12	sl+2*ul
2	USO Correction Factor (ratio)	10-9	4	sl
3	Mode ID		2	us (see table 2.3.3-2)
4	Source Sequence Counter		2	us (see note 6)
5	Instrument Configuration		4	ul (see table 2.3.3-3)
6	Burst counter (always starts from 1 and incremented at group rate)		4	ul
7	Latitude of measurement	10 ⁻¹ μdeg	4	sl (see note 1)
8	Longitude of measurement	10 ⁻¹ μdeg	4	sl (see note 1)
9	Altitude of COG above reference ellipsoid (interpolated value)	mm	4	sl
10	Instantaneous altitude rate derived from orbit	mm/s	4	sl
11	Satellite velocity vector[3] (in ITRF)	mm/s	3*4	sl
12	Real beam direction vector[3] (in CRF)	μm	3*4	sl
13	Interferometer baseline vector[3] (in CRF)	μm	3*4	sl
14	FBR Measurement Confidence Data (flag word)		4	ul (see table 2.3.3-4)
Measurements Group				
15	Window Delay (2way) uncorrected for instrument delays	10-12 s	8	sll
16	Ho Initial Height Word	48.8 ps	4	sl (see note 2)
17	COR2 Height Rate	3.05 ps/rc	4	sl (see note 2)
18	Coarse Range Word LAI	12.5 ns	4	sl (see note 2)
19	Fine Range Word FAI	12.5/256 ns	4	sl (see note 2)
20	AGC_1 (not corrected)	dB/100	4	sl (see note 3)
21	AGC_2 (not corrected)	dB/100	4	sl (see note 3)
22	Total Fixed Gain Rx 1	dB/100	4	sl (see note 3)
23	Total Fixed Gain Rx 2	dB/100	4	sl (see note 3)
24	Transmit Power	Micro-Watts	4	sl
25	Doppler range correction (Radial component)	mm	4	sl
26	Instrument Range Correction tx-rx antenna (from CAL1)	mm	4	sl
27	Instrument Range Correction	mm	4	sl



Advanced Computer Systems



Instrument Processing Facility L1b

Doc. No.: CS-RS-ACS-GS-5106
 Issue: 4.0
 Date: 10/12/2007
 Page: 44

Deleted: 3

Deleted: 2

Deleted: 3

Deleted: 07

	rx only antenna (from CAL1)			
28	Instrument Gain correction, tx-rx antenna (from CAL1)	dB/100	4	sl (see note 3)
29	Instrument Gain correction rx only antenna (from CAL1)	dB/100	4	sl (see note 3)
30	Internal Phase Correction	Microradians	4	sl
31	External Phase Correction	Microradians	4	sl
32	Noise power measurement	dB/100	4	sl (see note 3)
33	Spares		8*1	uc
Corrections Group				
34	Dry Tropospheric Correction	mm	4	sl
35	Wet Tropospheric Correction	mm	4	sl
36	Inverse Barometric Correction	mm	4	sl
37	DORIS Ionospheric Correction	mm	4	sl
38	Model Ionospheric Correction	mm	4	sl
39	Ocean Equilibrium Tide	mm	4	sl
40	Long Period Tide Height	mm	4	sl
41	Ocean Loading Tide	mm	4	sl
42	Solid Earth Tide	mm	4	sl
43	Geocentric Polar Tide	mm	4	sl
44	Surface type flag		4	ul
45	Correction status flags		4	ul (see table 2.3.3-5)
46	Correction error flags		4	ul (see table 2.3.3-6)
47	Spare		12*1	uc
Sub-Total Size			3424 bytes	



Advanced Computer Systems



Instrument Processing Facility L1b

Doc. No.: CS-RS-ACS-GS-5106
 Issue: 4.0
 Date: 10/12/2007
 Page: 45

Deleted: 3

Deleted: 2

Deleted: 3

Deleted: 07

Waveform group (PL)						
48	Averaged Power Echo Waveform[128]	FFT Power Units	128*2	us		
49	Number of echoes averaged		2	us		
50	Flag		2	us		
Sub-Total Size			5200 bytes			
Total Record Size			8624 bytes			

Waveform group (SAR)				
51	Complex Echo Waveform[64,128,2]		64*128*2	sc (see note 5)
52	Number of pulses in burst		2	us
53	Flag		2	us
Sub-Total Size			327760 bytes	
Total Record Size			331184 bytes	

Waveform group (SARin)				
54	Complex Echo Waveform[64,512,2] antenna 1 (Tx-Rx)		64*512*2	sc (see note 5)
55	Complex Echo Waveform[64,512,2] antenna 2 (Rx only)		64*512*2	sc (see note 5)
56	Number of pulses in burst		2	us
57	Flag		2	us
Sub-Total Size			2621520 bytes	
Total Record Size			2624944 bytes	

Table2.3.3-1: FBR MDS Records

Notes:

- 1) this is an exotic unit exclusively used at binary record level to improve resolution of the lat and long fields
- 2) These are exotic units specific of SIRAL instrument
- 3) This is an exotic unit used for db-units related fields.
- 5) Complex echo samples are packed in bytes for both SAR and SARIN, The "Q" byte is followed by the "I" byte.

Deleted: exotic



Advanced Computer Systems



Instrument Processing Facility L1b

Doc. No.: CS-RS-ACS-GS-5106
Issue: 4.0
Date: 10/12/2007
Page: 46

Deleted: 3.

Deleted: 2

Deleted: 3

Deleted: 07

6) The field Source Sequence Counter is copied from LRM L0 for LRM FBR – from ECHO-SAR L0 –first packet of group for FBR SAR – ECHO-SARIN L0 of Master channel, first packet of group, for FBR SARIN.

 <p>Advanced Computer Systems</p>		<p><i>Instrument Processing Facility L1b</i></p> <p>Doc. No.: CS-RS-ACS-GS-5106 Issue: 4.0 Date: 10/12/2007 Page: 47</p>
--	---	---

- Deleted: 3
- Deleted: 2
- Deleted: 3
- Deleted: 07

Fields Descriptions:

Field 1) MDSR Time Stamp - corresponding to ground bounce time of the individual pulse, or middle of group of pulses for LRM.

Field 2) USO Correction factor - this is the correction factor for USO drift defined as the ratio between the nominal and the measured value.

Field 3) Mode ID - (us giving 16 bits) Identifies the SIRAL instrument measurement mode. See Table 2.3.3-2:

ID	Definition	Bit (*)	Bit (**)	Setting
1.	Instrument Operative Mode	15-10	0-5	1 = LRM 2 = SAR 3 = SARIN 11 = CAL1-LRM 12 = CAL1-SAR 13 = CAL1-SARIN 22 = CAL2-SAR 23 = CAL2-SARIN 33 = CAL3
2.	SARIn Degraded Case	9	6	0 : Nominal SARIN Scenario 1: Contingency SARIN Scenario (1 Rx chain missing)
3.	Reserved	8	7	Set to zero
4.	CAL4 Flag	7	8	1 if CAL4 packets detected
5.	Platform Attitude Control	6-5	9-10	0 = Unknown 1 = Local Normal Pointing 2 = Yaw Steering
6.	Reserved	4-0	11-15	Set to zero

(*) Ground Segment bit numbering standard [FMT-Guide]

(**) Space Segment bit numbering standard

Table 2.3.3-2: Mode_ID



Advanced Computer Systems



Instrument Processing Facility L1b

Doc. No.: CS-RS-ACS-GS-5106
 Issue: 4.0
 Date: 10/12/2007
 Page: 48

- Deleted: 3.
- Deleted: 2
- Deleted: 3
- Deleted: 07

Field 4) Source Sequence Counter - read from the L0 Echo telemetry packet (of the master channel in the case of SARin). This is a 16384 cyclic modulo counter, starting from 0, incrementing by 1. A separate counter is maintained for each instrument mode.

Field 5) Instrument Config flag - this is derived from flags in the L0 packets for tracking and the echo telemetry. see Table 2.3.3-3:

Deleted: 4.3.1-2

ID	Definition	Bit (*)	Bit (**)	Setting
1.	Rx chain in use	31-30	0-1	1 = Rx1 2 = Rx2 3 = Both 0 = Unknown
2.	<u>SIRAL Identifier</u>	29	2	0 = Nominal 1 = Redundant
3.	Reserved	28	3	Set to zero
4.	Bandwidth	27-26	4-5	1 = 320 Mhz 2 = 40 Mhz 0 = Unknown
5.	Reserved	25-24	6-7	Set to zero
6.	Tracking Mode	23-22	8-9	1 = LRM 2 = SAR 3 = SARIN 0 = Unknown
7.	External Calibration	21	10	0 = no 1 = External Calibration
8.	Reserved	20	11	Set to zero
9.	Loop Status	19	12	0 = closed loop 1 = open loop
10.	Loss of Echo (from Cycle Report)	18	13	0 = OK 1 = Loss of Echo
11.	Real Time Error (from Cycle Report)	17	14	0 = OK 1 = Real Time Computation Error
12.	Echo Saturation Error (from Cycle Report)	16	15	0 = OK 1 = Echo Saturation Error
13.	Rx Band Attenuation	15	16	0 = not applied 1 = applied
14.	Cycle Report General Error	14	17	0 = Cycle Report is 0 1 = Cycle Report is not 0

Formatted: Left, Line spacing: single

Formatted: Line spacing: single

Deleted: 2

Deleted: 29-

Deleted: 2-

Deleted: 3

Deleted: 4

Deleted: 5

Deleted: 6

Deleted: 7

Deleted: 8

Deleted: 9

Deleted: 10

Deleted: 11

Deleted: 12

Deleted: 13

 Advanced Computer Systems		<i>Instrument Processing Facility L1b</i> Doc. No.: CS-RS-ACS-GS-5106 Issue: 4.0 Date: 10/12/2007 Page: 49
--	---	---

- Deleted: 3
- Deleted: 2
- Deleted: 3
- Deleted: 07
- Deleted: 14
- Deleted: 15
- Deleted: 16
- Deleted: 17

15.	Star Tracker 1 used	13	18	Set to 1 if Star Tracker 1 is used
16.	Star Tracker 2 used	12	19	Set to 1 if Star Tracker 2 is used
17.	Star Tracker 3 used	11	20	Set to 1 if Star Tracker 3 is used
18.	Reserved	10-0	21-31	Set to zero

(*) Ground Segment bit numbering standard [FMT-Guide]

(**) Space Segment bit numbering standard

Table 2.3.3-3: Instrument Config

Field 6) High-rate block counter - will increment from 1 for each data block. Hence the first full MDS record will contain the numbers 1-20, the second 21-40, etc.

Field 7) Latitude of measurement - corresponding to the MDSR Time Stamp.

Field 8) Longitude of measurement - corresponding to the MDSR Time Stamp.

Field 9) Altitude - altitude of the Satellite CoM above reference ellipsoid corresponding to the MDSR Time Stamp.

Field 10) Altitude rate - (as for Latitude)

Field 11) Satellite velocity vector -described in the International Terrestrial Reference Frame in the International Earth Fixed System. From Orbit CFI call. This is not a unit vector as the velocity magnitude is also required.

Field 12) Real beam direction vector - described in the Cryosat Reference Frame. This is a unit vector and note that the units are micro-metres.

Field 13. Interferometric baseline vector - described in the Cryosat Reference Frame. This is a unit vector and note that the units are micro-metres.

Field 14. FBR MCD - Measurement confidence flags. Generally the MCD flags indicate problems when set. If the whole MCD is 0 then no problems or non-nominal conditions were detected. Serious errors (highlighted in the table) are indicated by setting bit 31 (SS bit 0). In which case the block must not be processed. Other error settings can be regarded as warnings. See table 2.3.3-4:



Advanced Computer Systems



Instrument Processing Facility L1b

Doc. No.: CS-RS-ACS-GS-5106
 Issue: 4.0
 Date: 10/12/2007
 Page: 50

Deleted: 3

Deleted: 2

Deleted: 3

Deleted: 07

ID	Definition	Bit (*)	Bit (**)	Setting
1.	Block Degraded	31	0	0 = OK 1 = Degraded (set if the block should not be processed – indicated by bold typeface & shading)
2.	Blank Block	30	1	0 = OK 1 = Blank Block inserted for record padding
3.	Datation Degraded	29	2	0 = OK 1 = Datation is bad or not set
4.	Orbit Propagation Error	28	3	0 = OK 1 = Error (returned by CFI or independent check)
5.	Orbit File Change	27	4	0 = OK 1 = Orbit file has changed wrt previous record
6.	Orbit Discontinuity	26	5	0 = OK 1 = discontinuity (e.g. gap)
7.	Echo Saturation (from Cycle Report)	25	6	0 = OK 1 = Saturated
8.	Other Echo Error	24	7	0 = OK 1 = Echo Error (bit fields Tracking Echo Error or Echo Rx1 Error or Echo Rx2 Error set to 1)
9.	Rx 1 Channel Error for SARIN	23	8	0 = OK 1 = degraded or missing
10.	Rx 2 Channel error for SARIN	22	9	0 = OK 1 = degraded or missing
11.	Window Delay Inconsistency	21	10	0 = OK (value is in range) 1 = value out of range or



Advanced Computer Systems



Instrument Processing Facility L1b

Doc. No.: CS-RS-ACS-GS-5106
 Issue: 4.0
 Date: 10/12/2007
 Page: 51

Deleted: 3.

Deleted: 2

Deleted: 3

Deleted: 07

				computation error
12.	AGC Inconsistency	20	11	0 = OK (value is in range) 1 = value out of range or computation error
13.	Cal1 Correction Missing	19	12	0 = correction applied 1 = correction not applied
14.	Cal1 Correction from IPF DB	18	13	0 = correction from CAL1 Product used 1 = correction from IPF DB used
15.	DORIS USO Correction	17	14	0 = USO Correction Factor is available 1 = USO Correction Factor is not available
16.	Complex Cal1 Correction from IPF DB	16	15	0 = correction from Complex CAL1 Product used 1 = correction from IPF DB used
17.	TRK Echo Error	15	16	0 = OK 1 = empty (or null) tracking echo
18.	Echo Rx 1 Error	14	17	0 = OK 1 = empty (or null) raw echo
19.	Echo Rx2 Error	13	18	0 = OK 1 = empty (or null) raw echo
20.	NPM Inconsistency	12	19	0 = OK 1 = value out of range or computation error
21	Reserved	11-4	20-27	Set to zero

 <p>Advanced Computer Systems</p>		<p><i>Instrument Processing Facility L1b</i></p> <p>Doc. No.: CS-RS-ACS-GS-5106 Issue: 4.0 Date: 10/12/2007 Page: 52</p>
--	---	---

- Deleted: 3.
- Deleted: 2
- Deleted: 3
- Deleted: 07

22.	Attitude Correction Missing	3	28	0 = OK, attitude correction applied 1 = missing, xorrection not applied.
23.	Reserved	2-0	29-31	Set to zero

(*) Ground Segment bit numbering standard [FMT-Guide]

(**) Space Segment bit numbering standard

Table 2.3.3-4: FBR Measurement Confidence Data

 <p>Advanced Computer Systems</p>		<p><i>Instrument Processing Facility L1b</i></p> <p>Doc. No.: CS-RS-ACS-GS-5106 Issue: 4.0 Date: 10/12/2007 Page: 53</p>
--	---	---

- Deleted: 3
- Deleted: 2
- Deleted: 3
- Deleted: 07

Field 15) Window delay - The window delay from the telemetry converted to physical units. This is a 2-way measurement: the time taken for the radar pulse to travel to the surface and back.

Field 16) H0 - from telemetry

Field 17) COR2 - on-board tracker height rate over the radar cycle

Field 18) Coarse range word LAI - derived from telemetry

Field 19) Fine range word - derived from telemetry

Field 20) AGC1 - First AGC stage setting (applies to both receive channels) from telemetry. The value is commanded on board, from the tracker loop in normal operation. Gain calibration corrections are not applied. Note: the value is always an integer number of dB but units of db/100 are used to be consistent.

Field 21) AGC2 - Second AGC stage setting (applies to both receive channels) from telemetry

Field 22) Total Fixed Gain On Channel 1 - total fixed instrument gain applied on chain 1, this is the gain applied by the RF unit. see [R21] for details.

Field 23) Total Fixed Gain On Channel 2 - instrument fixed gain on receive chain 2 (as for chain 1)

Field 24) Transmit power in micro Watts.

Field 25) Doppler range correction - computed for the component of satellite velocity in the nadir direction.

Field 26) Instrument Range Correction (Tx-Rx chain) - Calibration correction to range on channel 1 computed from CAL1. (CAL1-LRM, CAL1-SAR and CAL1-SARin)

Field 27) Instrument Range Correction (Rx only chain) - Calibration correction to range on channel 2 computed from CAL1. (CAL1-LRM, CAL1-SAR and CAL1-SARin)

Field 28) Instrument Gain Correction (t-r chain) - Calibration correction to gain on channel 1 computed from CAL1. (Sometimes referred to as 'Sigma0 correction')

Field 29) Instrument Gain Correction (r only chain) - Calibration correction to gain on channel 2 computed from CAL1.

Field 30) Internal phase correction. - reserved for future use

Field 31) External phase correction. - reserved for future use

Field 32) Noise power measurement - converted from telemetry units to be the noise floor of FBR measurement echoes

Field 33) measurement spares - reserved for future use.

Field 34) Dry Tropospheric Correction - added to range measurement to correct for the propagation delay to the radar pulse, caused by the dry-gas component of the Earth's atmosphere.

 <p>Advanced Computer Systems</p>		<p><i>Instrument Processing Facility L1b</i></p> <p>Doc. No.: CS-RS-ACS-GS-5106 Issue: 4.0 Date: 10/12/2007 Page: 54</p>
--	---	---

- Deleted: 3.
- Deleted: 2
- Deleted: 3
- Deleted: 07

Field 35) Wet Tropospheric Correction - added to range measurement to correct for the propagation delay to the radar pulse, caused by the H2O component of the Earth's atmosphere.

Field 36) Inverse Barometric Correction - added to range measurement to correct for the depression of the ocean surface caused by the local barometric pressure.

Field 37) DORIS Ionospheric Correction - added to range measurement to correct for the delay to the Radar pulse caused by free electrons in the ionosphere. Computed from the concurrent DORIS data.

Field 38) Model Ionospheric Correction - added to range measurement to correct for the delay to the Radar pulse caused by free electrons in the ionosphere. Computed from an Ionospheric model.

Field 39) Ocean Tide - to be added to the range to remove the effect of local tide and adjust the measurement to the mean sea surface.

Field 40) Long-Period equilibrium Ocean Tide - a component of total ocean tide. To be added to range to correct for the tidal effect.

Field 41) Ocean Loading Tide - added to the range to remove the effect of local tidal distortion to the Earth's crust.

Field 42) Solid Earth Tide - added to the range to remove the effect of local tidal distortion in the Earth's crust.

Field 43) Geocentric Polar Tide - added to the range to remove the effect of movement of the Earth's rotational axis w.r.t. geographic location.

Field 44) Surface type flag - enumerated key to classify surface at nadir:

- 0 = Open Ocean
- 1 = Closed Sea
- 2 = Continental Ice
- 3 = Land

Field 45) Correction status flag - used to show which correction algorithms have been called, see Table 2.3.3-5.

Field 46) Correction error flag - used to show if a correction algorithms returned an error when called, see Table 2.3.3-6.

Field 47) Correction spares - reserved for future use.



Advanced Computer Systems



Instrument Processing Facility L1b

Doc. No.: CS-RS-ACS-GS-5106
 Issue: 4.0
 Date: 10/12/2007
 Page: 55

Deleted: 3.

Deleted: 2

Deleted: 3

Deleted: 07

ID	Definition	Bit (*)	Bit (**)	Setting
1.	Dry Tropospheric Correction Called	31	0	0 = no, 1 = yes
2.	Wet Tropospheric Correction Called	30	1	0 = no, 1 = yes
3.	Inverse Barometric Correction Called	29	2	0 = no, 1 = yes
4.	DORIS Ionospheric Correction Called	28	3	0 = no, 1 = yes
5.	Model Ionospheric Correction Called	27	4	0 = no, 1 = yes
6.	Ocean Equilibrium Tide Called	26	5	0 = no, 1 = yes
7.	Ocean Long Period Tide Called	25	6	0 = no, 1 = yes
8.	Ocean Loading Tide Called	24	7	0 = no, 1 = yes
9.	Solid Earth Tide Called	23	8	0 = no, 1 = yes
10.	Geocentric Polar Tide Called	22	9	0 = no, 1 = yes
11.	Surface type flag Called	21	10	0 = no, 1 = yes
12.	reserved	20-0	11-31	set to 0

(*) Ground Segment bit numbering standard [FMT-Guide]

(**) Space Segment bit numbering standard

Table 2.3.3-5: Correction status flags



Advanced Computer Systems



Instrument Processing Facility L1b

Doc. No.: CS-RS-ACS-GS-5106
Issue: 4.0
Date: 10/12/2007
Page: 56

Deleted: 3.

Deleted: 2

Deleted: 3

Deleted: 07

ID	Definition	Bit (*)	Bit (**)	Setting
1.	Dry Tropospheric Correction Error	31	0	0 = OK, 1 = error
2.	Wet Tropospheric Correction Error	30	1	0 = OK, 1 = error
3.	Inverse Barometric Correction Error	29	2	0 = OK, 1 = error
4.	DORIS Ionospheric Correction Error	28	3	0 = OK, 1 = error
5.	Model Ionospheric Correction Error	27	4	0 = OK, 1 = error
6.	Ocean Equilibrium Tide Error	26	5	0 = OK, 1 = error
7.	Ocean Long Period Tide Error	25	6	0 = OK, 1 = error
8.	Ocean Loading Tide Called	24	7	0 = OK, 1 = error
9.	Solid Earth Tide Called	23	8	0 = OK, 1 = error
10.	Geocentric Polar Tide Called	22	9	0 = OK, 1 = error
12.	Surface type flag Error	21	10	0 = OK, 1 = error
13.	reserved	20-0	11-31	set to 0

(*) Ground Segment bit numbering standard [FMT-Guide]

(**) Space Segment bit numbering standard

Table 2.3.3-6: Correction error flags

- Waveform Group for Low Rate Mode (Pulse Limited mode):

Field 48) Averaged Power Echo - Array of 128 bins. Averaged from 91 individual echoes in Pulse limited mode (LRM). Units are in 'counts' or 'FFT filter units'.

Field 49) Number of echoes averaged - normally 91 but may be lower if some individual echoes are missing or rejected.

Field 50) Flags - for errors or information about echoes. Currently not used – Reserved for future use.

- Waveform Group for SAR Mode

Field 51) Complex Echo Waveform - Array of 64 echoes * 128 bins * 2 for I & Q samples. These are stored as signed characters, as they were in the telemetry.

Field 52) Number of echoes in burst - normally 64. If lower some of the echoes in field 51. will be filled with zeroes.

Field 53) Flags - for errors or information about echoes. Currently not used – Reserved for future use.



Advanced Computer Systems



Instrument Processing Facility L1b

Doc. No.: CS-RS-ACS-GS-5106
Issue: 4.0
Date: 10/12/2007
Page: 57

Deleted: 3.

Deleted: 2

Deleted: 3

Deleted: 07

▪ Waveform Group for SARin Mode

Field 54) Complex Echo Waveform antenna 1- Array of 64 echoes * 512 bins * 2 for I & Q samples. These are stored as signed characters, as they were in the telemetry.

Field 55) Complex Echo Waveform antenna 1- Array of 64 echoes * 512 bins * 2 for I & Q samples. These are stored as signed characters, as they were in the telemetry.

Field 56) Number of echoes in burst - normally 64. If lower some of the echoes in field 51. will be filled with zeroes.

Field 57) Flags - for errors or information about echoes. Currently not used – Reserved for future use.

 <p>Advanced Computer Systems</p>		<p><i>Instrument Processing Facility L1b</i></p> <p>Doc. No.: CS-RS-ACS-GS-5106 Issue: 4.0 Date: 10/12/2007 Page: 58</p>
--	---	---

- Deleted: 3.
- Deleted: 2
- Deleted: 3
- Deleted: 07

2.3.4 FBR CAL3 MDS Record Structure

This type of FBR product is introduced for the specific need of defining a clear data interface between the IPF1 Pre-Processor and the CAL3 Specific Processor. The MDS is composed by:

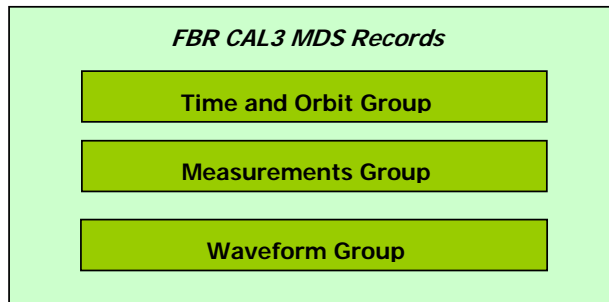

Geophysical corrections are not available in this product. They are of no relevance for the processing since the purpose of the CAL3 measurement is actually to perform “relative” rather than “absolute” measurements.

Field	Descriptor	Unit	Bytes	Format
Time and Orbit Group				
1	Data Record Time (MDSR Time Stamp)	TAI	12	sl+2*ul
2	USO Correction Factor (Ratio)	10-9	4	sl
3	Mode ID	-	2	us (see table 2.3.3-2)
4	Source Sequence Count	-	2	Us (see note 6)
5	Instrument Configuration		4	ul (see table 2.3.3-3)
6	Record Counter (always starts from 1 and incremented at group rate)	-	4	ul
7	Latitude of Measurement	10 ⁻¹ μdeg	4	sl (see note 1)
8	Longitude of Measurement	10 ⁻¹ μdeg	4	sl (see note 1)



Advanced Computer Systems



Instrument Processing Facility L1b

Doc. No.: CS-RS-ACS-GS-5106
 Issue: 4.0
 Date: 10/12/2007
 Page: 59

Deleted: 3

Deleted: 2

Deleted: 3

Deleted: 07

9	Altitude of COG above reference ellipsoid	mm	4	sl
10	Instantaneous Height Rate derived from Orbit	mm/s	4	sl
11	Satellite Velocity Vector [3] (in ITRF)	mm/s	3 x 4	sl
12	Real Beam Direction Vector [3] (in CRF)	μm	3 x 4	sl
13	Interferometer Baseline Vector [3] (in CRF)	μm	3 x 4	sl
14	FBR CAL3 Measurement Confidence Data	-	4	ul (see table 2.3.3-4)
Measurements Group				
15	Window Delay (2way) uncorrected for instrument delays	10-12 s	8	sll
16	Ho Initial Height Word	48.8 ps	4	sl (see note 2)
17	HPR Height Rate per radar cycle	3.05 ps/rc	4	sl (see note 2)
18	LAI	12.5 ns	4	sl (see note 2)
19	FAI	12.5/256 ns	4	sl (see note 2)
20	AGC_1 (not corrected)	dB/100	4	sl (see note 3)
21	AGC_2 (not corrected)	dB/100	4	sl (see note 3)
22	Total Fixed Gain Rx 1	dB/100	4	sl (see note 3)
23	Total Fixed Gain Rx 2	dB/100	4	sl (see note 3)
24	Transmit Power	microWatts	4	sl
25	Doppler range correction (Radial component)	mm	4	sl
26	Instrument Range Correction tx-rx antenna	mm	4	sl
27	Instrument Range Correction rx only antenna	mm	4	sl
28	Instrument Sigma 0 correction, tx-rx antenna	dB/100	4	sl (see note 3)
29	Instrument Sigma 0 correction rx only antenna	dB/100	4	sl (see note 3)
30	Internal Phase Correction	microradians	4	sl
31	External Phase Correction	microradians	4	sl
32	Noise power measurement	dB/100	4	sl (see note 3)
33	Spares		8*1	uc
Sub-Total Size			168 bytes	
Waveform Group				
33	Complex Echo Waveforms [91,128,2] Ant 1	-	91*128*2	sc (see note 5)

 <p>Advanced Computer Systems</p>		<p><i>Instrument Processing Facility L1b</i></p> <p>Doc. No.: CS-RS-ACS-GS-5106 Issue: 4.0 Date: 10/12/2007 Page: 60</p>
--	---	---

Deleted: 3
Deleted: 2
Deleted: 3
Deleted: 07

34	Complex Echo Waveforms [91,128,2] Ant 2	-	91*128*2	sc
35	Spare		2*1	uc
36	Flags		2	us
Total Record Size			46764 bytes	

Table 2.3.4-1: FBR CAL3 MDS Records

Notes:

- 1) this is an exotic unit exclusively used at binary record level to improve resolution of the lat and long fields
- 2) These are exotic units specific of SIRAL instrument
- 3) This is an exotic unit used for db-units related fields.
- 5) Complex echo samples are packed in bytes, The "Q" byte is followed by the "I" byte.
- 6) The field Source Sequence Counter is copied from LRM L0 for LRM FBR – from ECHO-SAR L0 –first packet of group for FBR SAR – ECHO-SARIN L0 of Master channel, first packet of group, for FBR SARIN.

Deleted: exotic

For fields descriptions please refer to descriptions of fields from 1 to 33 in paragraph 2.3.3.

Deleted: e

 <p>Advanced Computer Systems</p>		<p><i>Instrument Processing Facility L1b</i></p> <p>Doc. No.: CS-RS-ACS-GS-5106 Issue: 4.0 Date: 10/12/2007 Page: 61</p>
--	---	---

- Deleted: 3
- Deleted: 2
- Deleted: 3
- Deleted: 07

2.3.5 L1b LRM(FDM²)/SAR/SARin Data Products MDS Record Structure

This MDS is composed by:

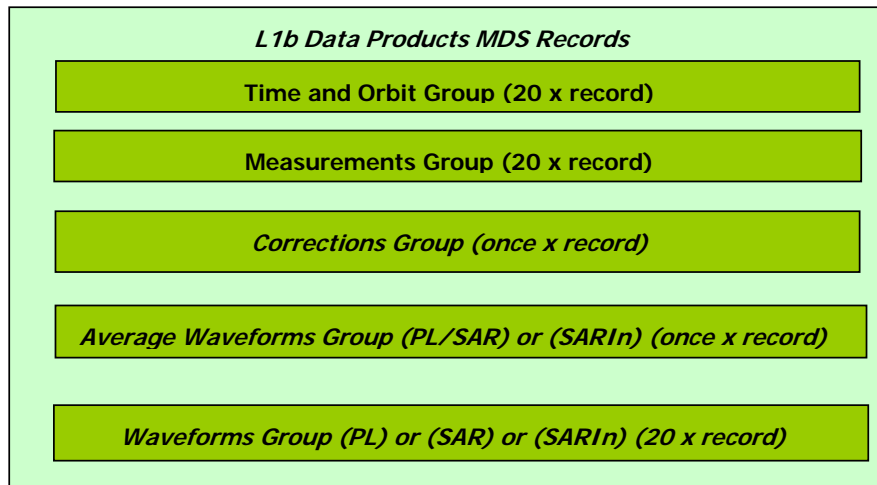

The L1b MDS has actually three variations depending on the Mode. The data record is arranged so that the first part is common to all modes. Time and Orbit Group and Measurements Group are in blocks of 20 per record. Corrections are made available once per record. The common part is then followed by:

- a 1 Hz averaged waveform
- a set of 20 Waveforms

Waveforms are mode dependent and thus specific layouts are defined.

² Fast Delivery Ocean (FDM) product is produced for LRM mode data only and is run as soon as possible after acquisition. The FBR and L1B FDM products have the same record structure as LRM



Advanced Computer Systems



Instrument Processing Facility L1b

Doc. No.: CS-RS-ACS-GS-5106
 Issue: 4.0
 Date: 10/12/2007
 Page: 62

Deleted: 3.

Deleted: 2

Deleted: 3

Deleted: 07

Field	Description	Units	Bytes	Format
Time and Orbit Group (structure repeated 20 times per record)				
1	Data Record Time (MDSR Time Stamp)	TAI	12	sl+2*ul
2	USO Correction Factor (Ratio)	10-9	4	sl
3	Mode ID	-	2	us (see table 2.3.3-2)
4	Source Sequence Counter (only for LRM – Spare in SAR & SARIN)		2	us
5	Instrument Configuration		4	ul (see table 2.3.3-3)
6	Burst counter (surface sample counter) (always starts from 1 and incremented at group rate)	-	4	ul
7	Latitude of measurement	10 ⁻¹ µdeg	4	sl (see note 1)
8	Longitude of measurement	10 ⁻¹ µdeg	4	sl (see note 1)
9	Altitude of COG above reference ellipsoid (interpolated value)	mm	4	sl
10	Instantaneous altitude rate derived from orbit	mm/sec	4	sl
11	Satellite velocity vector[3] (in ITRF)	mm/s	3*4	sl
12	Real beam direction vector[3] (in CRF)	µm	3*4	sl
13	Interferometer baseline vector[3] (in CRF)	µm	3*4	sl
14	Level 1b Measurement Confidence Data (flag word)	-	4	ul (see table 2.3.5-2)
Measurements Group (structure repeated 20 times per record)				
15	Window Delay (2way) corrected for instrument delays	10-12 s	8	sll
16	Ho Initial Height Word	48.8 ps	4	sl (see note 2)
17	COR2 Height Rate	3.05 ps/rc	4	sl (see note 2)
18	Coarse Range word LAI	12.5 ns	4	sl (see note 2)
19	Fine Range word FAI	12.5/256 ns	4	sl (see note 2)
20	AGC Channel 1 (corrected)	dB/100	4	sl (see note 3)
21	AGC Channel 2 (corrected)	dB/100	4	sl (see note 3)
22	Total Fixed Gain Rx 1	dB/100	4	sl (see note 3)
23	Total Fixed Gain Rx 2	dB/100	4	sl (see note 3)
24	Transmit Power	Micro-Watts	4	sl
25	Doppler range correction (Radial component)	mm	4	sl
26	Instrument Range Correction tx-rx antenna	mm	4	sl
27	Instrument Range Correction rx only antenna	mm	4	sl



Advanced Computer Systems



Instrument Processing Facility L1b

Doc. No.: CS-RS-ACS-GS-5106
 Issue: 4.0
 Date: 10/12/2007
 Page: 63

Deleted: 3

Deleted: 2

Deleted: 3

Deleted: 07

28	Instrument Gain correction tx-rx antenna	dB/100	4	sl (see note 3)
29	Instrument Gain correction rx only antenna	dB/100	4	sl (see note 3)
30	Internal Phase Correction	Microradians	4	sl
31	External Phase Correction	Microradians	4	sl
32	Noise power measurement	dB/100	4	sl (see note 3)
33	Spares		8*1	uc
Corrections Group (once per record)				
34	Dry Tropospheric Correction	mm	4	sl
35	Wet Tropospheric Correction	mm	4	sl
36	Inverse Barometric Correction	mm	4	sl
37	DORIS Ionospheric Correction	mm	4	sl
38	Model Ionospheric Correction	mm	4	sl
39	Ocean Tide	mm	4	sl
40	Long Period Tide Height	mm	4	sl
41	Ocean Loading Tide	mm	4	sl
42	Solid Earth Tide	mm	4	sl
43	Geocentric Polar Tide	mm	4	sl
44	Surface type flag	-	4	ul
45	Correction status flags	-	4	ul (see Table 2.3.3-5)
46	Correction error flags	-	4	ul (see Table 2.3.3-6)
47	Spare		12*1	uc
Sub-Total Size			3424 bytes	

Field	Descriptor	Unit	Bytes	Format
Average Waveform group: PL/SAR (once per record)				
48	Data Record Time (MDSR Time Stamp)	TAI	12	sl+2*ul
49	Latitude of measurement	10 ⁻¹ μdeg	4	sl (see note 1)
50	Longitude of measurement	10 ⁻¹ μdeg	4	sl (see note 1)
51	Altitude of COG above reference ellipsoid (interpolated value)	mm	4	sl
52	Window Delay (2way) corrected for instrument delays	10-12 s	8	sll
53	1 Hz Averaged Power Echo Waveform[128]	Scaled	128*2	us
54	Echo Scale Factor (to scale echo to watts)	-	4	sl
55	Echo Scale Power (a power of 2)		4	sl
56	Number of echoes averaged	-	2	us



Advanced Computer Systems



Instrument Processing Facility L1b

Doc. No.: CS-RS-ACS-GS-5106
 Issue: 4.0
 Date: 10/12/2007
 Page: 64

Deleted: 3

Deleted: 2

Deleted: 3

Deleted: 07

57	Flags	-	2	us (see Table 2.3.5-3/4)
Sub-Total Size			300 bytes	

Field	Descriptor	Unit	Bytes	Format
Average Waveform group: SARIN (once per record)				
58	Data Record Time (MDSR Time Stamp)	TAI	12	sl+2*ul
59	Latitude of measurement	10 ⁻¹ μdeg	4	sl (see note 1)
60	Longitude of measurement	10 ⁻¹ μdeg	4	sl (see note 1)
61	Altitude of COG above reference ellipsoid (interpolated value)	mm	4	sl
62	Window Delay (2way) corrected for instrument delays	10-12 s	8	sll
63	1 Hz Averaged Power Echo Waveform[512]	Scaled	512*2	us
64	Echo Scale Factor (to scale echo to watts)	-	4	sl
65	Echo Scale Power (a power of 2)	-	4	sl
66	Number of echoes averaged	-	2	us
67	Flags	-	2	us
Sub-Total Size			1068 bytes	

Field	Descriptor	Unit	Bytes	Format
Waveform group: PL (structure repeated 20 times per record)				
68	Averaged Power Echo Waveform[128]	Scaled	128*2	us
69	Echo Scale Factor (to scale echo to watts)	-	4	sl
70	Echo Scale Power (a power of 2)	-	4	sl
71	Number of echoes averaged	-	2	us
72	Flags	-	2	us
Sub-Total Size			5360 bytes	
Total Record Size			9084 bytes	

Field	Descriptor	Unit	Bytes	Format
Waveform group: SAR (structure repeated 20 times per record)				
73	Averaged Power Echo Waveform [128]	Scaled	128*2	us
74	Echo Scale Factor (to scale echo to watts)	-	4	sl



Advanced Computer Systems



Instrument Processing Facility L1b

Doc. No.: CS-RS-ACS-GS-5106
 Issue: 4.0
 Date: 10/12/2007
 Page: 65

Deleted: 3.

Deleted: 2

Deleted: 3

Deleted: 07

75	Echo Scale Power (a power of 2)		4	sl
76	Number of echoes averaged	-	2	us
77	Flags	-	2	us
78	Beam behaviour parameter [50]	-	50*2	ss
Sub-Total Size			7360 bytes	
Total Record Size			11084 bytes	

Field	Descriptor	Unit	Bytes	Format
Waveform group (SARin) (Structure repeated 20 times per record)				
79	Averaged Power Echo Waveform[512]	Scaled	512*2	us
80	Echo Scale Factor (to scale echo to watts)	-	4	sl
81	Echo Scale Power (a power of 2)		4	sl
82	Number of echoes averaged	-	2	us
83	Flags	-	2	us
84	Beam behaviour parameter [50]		50*2	ss (see table 2.3.5-4)
85	Coherence [512]	1/1000	512*2	us
86	Phase difference [512]	microrad	512*4	sl
Sub-Total Size			84160 bytes	
Total Recod Size			88652 bytes	

Table 2.3.5-1: L1b Data Products MDS Records

 <p>Advanced Computer Systems</p>		<p><i>Instrument Processing Facility L1b</i></p> <p>Doc. No.: CS-RS-ACS-GS-5106 Issue: 4.0 Date: 10/12/2007 Page: 66</p>
--	---	---

- Deleted: 3
- Deleted: 2
- Deleted: 3
- Deleted: 07

Notes:

1) this is an exotic unit exclusively used at binary record level to improve resolution of the lat and long fields

2) These are exotic units specific of SIRAL instrument

Deleted: exotic

3) This is an exotic unit used for db-units related fields.

Field 1) MDSR Time Stamp - corresponding to ground bounce time of the individual pulse, or middle of group of pulses for LRM.

Field 2) USO Correction factor - this is the correction factor for USO drift defined as the ratio between the nominal and the measured value.

Field 3) Mode ID - Identifies the SIRAL instrument measurement mode. See table 2.3.3-2

Field 4) Source Sequence Counter - read from the L0 Echo telemetry packet (of the master channel in the case of SARin). This is a 16384 cyclic modulo counter, starting from 0, incrementing by 1. A separate counter is maintained for each instrument mode.

Field 5) Instrument Config flag - This is derived from flags in the L0 packets for tracking and the echo. see table 2.3.3-3.

Field 6) Record counter - will increment from 1 for each data block. Hence the first full MDS record will contain the numbers 1-20, the second 21-40, etc.

Field 7) Latitude of measurement - corresponding to the MDSR Time Stamp.

Field 8) Longitude of measurement - (as for Latitude)

Field 9) Altitude - altitude of the Satellite CoM above reference ellipsoid - (as for Latitude)

Field 10) Altitude rate - (as for Latitude)

Field 11) Satellite velocity vector - in International Terrestrial Reference Frame in the International Earth Fixed System.

Field 12) Real beam direction vector - described in the Cryosat Reference Frame. Unit vector in micro-metres.

Field 13) Interferometric baseline vector - Cryosat Reference Frame. Unit vector in micro-metres.

Field 14) L1B MCD - Measurement confidence flags. Generally the MCD flags indicate problems when set. If the whole MCD is 0 then no problems or non-nominal conditions were detected. Serious errors are indicated by setting bit 31 (SS bit 0). In which case the block must not be processed. Other error settings can be regarded as warnings. See table 2.3.5-2:



Advanced Computer Systems



Instrument Processing Facility L1b

Doc. No.: CS-RS-ACS-GS-5106
 Issue: 4.0
 Date: 10/12/2007
 Page: 67

Deleted: 3.

Deleted: 2

Deleted: 3

Deleted: 07

ID	Definition	Bit (*)	Bit (**)	Setting
1.	Block Degraded	31	0	0 = OK 1 = Degraded (set if the block should not be processed – indicated by bold typeface & shading)
2.	Blank Block	30	1	0 = OK 1 = Blank Block inserted for record padding
3.	Datation Degraded	29	2	0 = OK 1 = Datation is bad or not set
4.	Orbit Propagation Error	28	3	0 = OK 1 = Error (returned by CFI or independent check)
5.	Orbit File Change	27	4	0 = OK 1 = Orbit file has changed wrt previous record
6.	Orbit Discontinuity	26	5	0 = OK 1 = discontinuity (e.g. gap)
7.	Echo Saturation (from Cycle Report)	25	6	0 = OK 1 = Saturated
8.	Other Echo Error	24	7	0 = OK 1 = Echo Error (bit fields Tracking Echo Error or Echo Rx1 Error or Echo Rx2 Error set to 1)
9.	Rx 1 Channel Error for SARIN	23	8	0 = OK 1 = degraded or missing
10.	Rx 2 Channel error for SARIN	22	9	0 = OK 1 = degraded or missing
11.	Window Delay	21	10	0 = OK (value is in range)



Advanced Computer Systems



Instrument Processing Facility L1b

Doc. No.: CS-RS-ACS-GS-5106
 Issue: 4.0
 Date: 10/12/2007
 Page: 68

Deleted: 3.

Deleted: 2

Deleted: 3

Deleted: 07

	Inconsistency			1 = value out of range or computation error
12.	AGC Inconsistency	20	11	0 = OK (value is in range) 1 = value out of range or computation error
13.	Cal1 Correction Missing	19	12	0 = correction applied 1 = correction not applied
14.	Cal1 Correction from IPF DB	18	13	0 = correction from CAL1 Product used 1 = correction from IPF DB used
15.	DORIS USO Correction	17	14	0 = USO Correction Factor is available 1 = USO Correction Factor is not available
16.	complex Cal1 Correction from IPF DB	16	15	0 = correction from Complex CAL1 Product used 1 = correction from IPF DB used
17.	TRK Echo Error	15	16	0 = OK 1 = empty (or null) tracking echo
18.	Echo Rx 1 Error	14	17	0 = OK 1 = empty (or null) raw echo
19.	Echo Rx2 Error	13	18	0 = OK 1 = empty (or null) raw echo
20.	NPM Inconsistency	12	19	0 = OK 1 = value out of range or computation error
21.	Azimuth Calibration Missing	11	20	0 = OK correction is applied 1 = No Azimuth Calibration
22.	Azimuth Calibration from IPF DB	10	21	0 = Default not used 1 = Default from IPF DB used
23.	Range Window Calibration Function Missing	9	22	0 = OK, Calibrated 1 = No Calibration Applied
24.	Range Window Calibration	8	23	0 = Default not used



Advanced Computer Systems



Instrument Processing Facility L1b

Doc. No.: CS-RS-ACS-GS-5106
 Issue: 4.0
 Date: 10/12/2007
 Page: 69

Deleted: 3

Deleted: 2

Deleted: 3

Deleted: 07

	Function from IPF DB			1 = Default from IPF DB used
25.	Reserved	7	24	Set to zero
26.	Cal2 Correction Missing	6	25	0 = correction applied 1 = correction not applied
27.	Cal 2 Correction from IPF DB	5	26	0 = correction from CAL1 Product used 1 = correction from IPF DB used
28.	Power Scaling Error (for LRM only)	4	27	0 = Ok (echo has been power scaled) 1 = Error in scaling (L1B waveform is null) Used only for LRM L1B
29.	Attitude Correction Missing	3	28	0 = OK, Correction Applied 1 = Not Corrected
30.	Attitude Interpolation Error	2	29	0 = OK 1 = Interpolation Error, attitude is wrong
31.	Reserved	1-0	30-31	Set to zero

(*) Ground Segment bit numbering standard [FMT-Guide]

(**) Space Segment bit numbering standard

Table 2.3.5-2: L1B Measurement Confidence Data

Field 15) Window delay - The window delay from the telemetry converted to physical units. Note that this is still a 2-way time, and so 2-way corrections are applied. COM offset is applied and Calibration correction from Cal1 is applied. Units are pico seconds.

Field 16) H0 - from telemetry

Field 17) COR2 - on-board tracker height rate over the radar cycle

Field 18) Coarse range word LAI - derived from telemetry

Field 19) Fine range word - derived from telemetry

Field 20) AGC ch 1 - AGC gain applied on Rx channel 1. Gain calibration corrections are applied. (Sum of AGC stages 1 and 2 plus the corresponding corrections)

Field 21) AGC ch 2 - AGC gain applied on Rx channel 2. Gain calibration corrections are applied.

 <p>Advanced Computer Systems</p>		<p><i>Instrument Processing Facility L1b</i></p> <p>Doc. No.: CS-RS-ACS-GS-5106 Issue: 4.0 Date: 10/12/2007 Page: 70</p>
--	---	---

- Deleted: 3
- Deleted: 2
- Deleted: 3
- Deleted: 07

Field 22) Total Fixed Gain On Channel 1 - total fixed instrument gain applied on chain 1, this is the gain applied by the RF unit.

Field 23) Total Fixed Gain On Channel 2 - instrument fixed gain on receive chain 2 (as for chain 1)

Field 24) Transmit power in micro Watts.

Field 25) Doppler range correction - computed for the component of satellite velocity in the nadir direction.

Field 26) Instrument Range Correction (Tx-Rx chain) - Calibration correction to range on channel 1 computed from CAL1.

Field 27) Instrument Range Correction (Rx only chain) - Calibration correction to range on channel 2 computed from CAL1.

Field 28) Instrument Gain Correction (Tx-Rx chain) - Calibration correction to gain on channel 1 computed from CAL1.

Field 29) Instrument Gain Correction (Rx only chain) - Calibration correction to gain on channel 2 computed from CAL1.

Field 30) Internal phase correction. - reserved for future use

Field 31) External phase correction. - reserved for future use

Field 32) Noise power measurement - converted from telemetry units to be the noise floor of FBR measurement echoes

Field 33) measurement spares - reserved for future use.

Field 34) Dry Tropospheric Correction - added to range measurement to correct for the propagation delay to the radar pulse, caused by the dry-gas component of the Earth's atmosphere.

Field 35) Wet Tropospheric Correction - added to range measurement to correct for the propagation delay to the radar pulse, caused by the H2O component of the Earth's atmosphere.

Field 36) Inverse Barometric Correction - added to range measurement to correct for the depression of the ocean surface caused by the local barometric pressure.

Field 37) DORIS Ionospheric Correction - added to range measurement to correct for the delay to the Radar pulse caused by free electrons in the ionosphere. Computed from the concurrent DORIS data.

Field 38) Model Ionospheric Correction - added to range measurement to correct for the delay to the Radar pulse caused by free electrons in the ionosphere. Computed from an Ionospheric model.

Field 39) Ocean Tide - to be added to the range to remove the effect of local tide and adjust the measurement to the mean sea surface.

 <p>Advanced Computer Systems</p>		<p><i>Instrument Processing Facility L1b</i></p> <p>Doc. No.: CS-RS-ACS-GS-5106 Issue: 4.0 Date: 10/12/2007 Page: 71</p>
--	---	---

- Deleted: 3
- Deleted: 2
- Deleted: 3
- Deleted: 07

Field 40) Long-Period equilibrium Ocean Tide - a component of total ocean tide. To be added to range to correct for the tidal effect.

Field 41) Ocean Loading Tide - added to the range to remove the effect of local tidal distortion to the Earth's crust.

Field 42) Solid Earth Tide - added to the range to remove the effect of local tidal distortion in the Earth's crust.

Field 43) Geocentric Polar Tide - added to the range to remove the effect of movement of the Earth's rotational axis w.r.t. geographic location.

Field 44) Surface type flag - enumerated key to classify surface at nadir:

- 0 = Open Ocean
- 1 = Closed Sea
- 2 = Continental Ice
- 3 = Land

Field 45) Correction status flag - used to show which correction algorithms have been called, see Table 2.3.3-5.

Field 46) Correction error flag - used to show if a correction algorithms returned an error when called, see Table 2.3.3-6.

Field 47) Correction spares - reserved for future use.

- Averaged Waveform Group for Low Rate Mode (PL mode) and SAR mode. (Once per L1b record)

Field 48) MDSR Time Stamp - corresponding to ground bounce time of the individual pulse, or middle of group of pulses for LRM.

Field 49) Latitude of measurement - corresponding to the MDSR Time Stamp.

Field 50) Longitude of measurement - (as for Latitude)

Field 51) Altitude - altitude of the Satellite CoM above reference ellipsoid - (as for Latitude)

Field 52) Window delay - The window delay from the telemetry converted to physical units. (2-way time)

Field 53) Averaged Power Echo - Array of 128 bins. Averaged from all individual L0 echoes in approx 1 second (20 for LRM, 5120 for SAR). Units are counts scaled to fit in the range 0-65535 and are converted to Watts by using the scaling parameters in the following 2 fields.

Field 54) Echo Scale factor 'A' (to scale echo to Watts)

Field 55) Echo Scale power 'B' (power of 2 to scale echo to Watts) the formula for converting the echo to Watts is: **Power in Watts = counts * (A * 10⁻⁹) * 2^B**

Field 56) Number of echoes averaged - normally 1820 for LRM (=91 averaged on-board *20) or 5120 for SAR, but may be lower if some individual echoes are missing or rejected.

 <p>Advanced Computer Systems</p>		<p><i>Instrument Processing Facility L1b</i></p> <p>Doc. No.: CS-RS-ACS-GS-5106 Issue: 4.0 Date: 10/12/2007 Page: 72</p>
--	---	---

- Deleted: 3
- Deleted: 2
- Deleted: 3
- Deleted: 07

Field 57) Flags - for errors or information about echoes.

ID	Definition	Bit (*)	Bit (**)	Setting
1.	1 Hz Echo Error	15	0	0 = Computed 1 = Not Computed
2.	Reserved	14-0	1-15	Set to zero

- (*) Ground Segment bit numbering standard [FMT-Guide]
- (**) Space Segment bit numbering standard

Table 2.3.5-3: Flags field in PL Average Waveform Group

ID	Definition	Bit (*)	Bit (**)	Setting
1.	1 Hz Echo Error	15	0	0 = Computed 1 = Not Computed
2.	Reserved	14-1	1-14	Set to zero
3.	Mispointing error	0	15	1=bad angles 0=no error

- (*) Ground Segment bit numbering standard [FMT-Guide]
- (**) Space Segment bit numbering standard

Table 2.3.5-4: Flags field in SAR Average Waveform Group

- Averaged Waveform Group for SARin mode (Once per L1b record)

This is the same as the above group but the waveform array is 512 bins instead of 128 and the number of echoes averaged is different.

Field 58) MDSR Time Stamp - corresponding to ground bounce time of the individual pulse, or middle of group of pulses for LRM.

Field 59) Latitude of measurement - corresponding to the MDSR Time Stamp.

Field 60) Longitude of measurement - (as for Latitude)

Field 61) Altitude - altitude of the Satellite CoM above reference ellipsoid - (as for Latitude)

Deleted: 3
Deleted: 2
Deleted: 3
Deleted: 07

Field 62) Window delay - The window delay from the telemetry converted to physical units. (2-way time)

Field 63) Averaged Power Echo - Array of 512 bins. Averaged from 1280 individual L0 echoes in SARin mode. Units are counts scaled to fit in the range 0-65535 and are converted to Watts by using the scaling parameters in the following 2 fields.

Field 64) Echo Scale factor 'A' (to scale echo to Watts)

Field 65) Echo Scale power 'B' (power of 2 to scale echo to Watts) the formula for converting the echo to Watts is: **Power in Watts = counts * (A*10⁻⁹) * 2^B**

Field 66) Number of echoes averaged - normally 1280 but may be lower if some individual echoes are missing or rejected.

Field 67. Flags - for errors or information about echoes (15 bit flag). See table 2.3.5-4

ID	Definition	PDS Bit	Setting
1	Approximate beam steering	15	0 = no, 1 = approximate steering used
2	Exact beam steering	14	0 = no, 1 = exact steering used
3	Doppler weighting computed	13	0 = not computed, 1 = computed
4	Doppler weighting applied before stack	12	0 = not applied, 1 = applied
5	Multi look incomplete	11	0 = no (i.e. complete), 1 = incomplete
6	Beam angle steering error	10	0 = OK, 1 = error
7	Anti aliased power echoes	9	0 = no, 1 = anti aliased
8	Auto beam steering	8	0 = no, 1 = auto beam steering used ³
9	reserved	7-0	set to 0

Table 2.3.5-4: SARIN Waveform Flags

- Waveform Group for LRM mode (20x per L1b record)

³ Beam steering method is chosen based on the on-board tracker height variation

 <p>Advanced Computer Systems</p>		<p><i>Instrument Processing Facility L1b</i></p> <p>Doc. No.: CS-RS-ACS-GS-5106 Issue: 4.0 Date: 10/12/2007 Page: 74</p>
--	---	---

- Deleted: 3
- Deleted: 2
- Deleted: 3
- Deleted: 07

Field 68) Averaged Power Echo - Array of 128 bins. Averaged (on-board) from 91 individual echoes in Pulse limited mode (LRM). Units are counts scaled to fit in the range 0-65535 and are converted to Watts by using the scaling parameters in the following 2 fields.

Field 69) Echo Scale factor 'A' (to scale echo to Watts)

Field 70) Echo Scale power 'B' (power of 2 to scale echo to Watts) the formula for converting the echo to Watts is: **Power in Watts = counts * (A * 10⁻⁹) * 2^B**

Field 71) Number of echoes averaged - normally 91.

Field 72) Flags - for errors or information about echoes (15 bit flag). See table 2.3.5-4.

- Waveform Group for SAR mode (20x per L1b record)

Field 73) Averaged Power Echo - Array of 128 bins. Averaged from a set of Doppler beam echoes formed at a common surface location. Units are counts scaled to fit in the range 0-65535 and are converted to Watts by using the scaling parameters in the following 2 fields.

Field 74) Echo Scale factor 'A' (to scale echo to Watts)

Field 75) Echo Scale power 'B' (power of 2 to scale echo to Watts) the formula for converting the echo to Watts is: **Power in Watts = counts * (A * 10⁻⁹) * 2^B**

Field 76) Number of echoes averaged - variable typically 280.

Field 77) Flags - for errors or information about echoes (15 bit flag). See table 2.3.5-4.

Field 78) Beam Behaviour parameter - an array of 50 integers to characterise the shape of the set of Doppler echoes from a common surface location prior to stacking (averaging). Currently the first 5 numbers are defined as in table 2.3.5-5, while the remainder are reserved for future use.

Index	Definition	Type	Setting
[0]	Standard Deviation	us	
[1]	Stack Centre (Beam in stack at maximum of the fitted gaussian)	us	
[2]	Stack Scaled Amplitude	us	
[3]	Stack Skewness	ss	Value/100 or -99900 if cannot be computed
[4]	Stack Kurtosis	ss	Value/100 or -99900 if cannot be computed
[5-49]	reserved		Set to zero

(*) Ground Segment bit numbering standard [FMT-Guide]

(**) Space Segment bit numbering standard

 <p>Advanced Computer Systems</p>		<p><i>Instrument Processing Facility L1b</i></p> <p>Doc. No.: CS-RS-ACS-GS-5106 Issue: 4.0 Date: 10/12/2007 Page: 75</p>
--	---	---

- Deleted: 3.
- Deleted: 2
- Deleted: 3
- Deleted: 07

Table 2.3.5-5: Flags Beam Behaviour Parameters

 <p>Advanced Computer Systems</p>		<p><i>Instrument Processing Facility L1b</i></p> <p>Doc. No.: CS-RS-ACS-GS-5106 Issue: 4.0 Date: 10/12/2007 Page: 76</p>
--	---	---

- Deleted: 3
- Deleted: 2
- Deleted: 3
- Deleted: 07

- Waveform Group for SARin mode (20x per L1b record)

Field 79) Averaged Power Echo - Array of 512 bins. Averaged from 2 sets of Doppler beam echoes formed (on 2 receive channels) at a common surface location. Units are counts scaled to fit in the range 0-65535 and are converted to Watts by using the scaling parameters in the following 2 fields.

Field 80) Echo Scale factor 'A' (to scale echo to Watts)

Field 81) Echo Scale power 'B' (power of 2 to scale echo to Watts) the formula for converting the echo to Watts is: **Power in Watts = counts * (A * 10⁻⁹) * 2^B**

Field 82) Number of echoes averaged - variable, typically 70.

Field 83) Flags - for errors or information about echoes (15 bit flag). See table 2.3.5-4

Field 84) Beam Behaviour parameter - an array of 50 integers to characterise the shape of the set of Doppler echoes from a common surface location prior to stacking (averaging). Currently the first 5 numbers are defined as in table 2.3.5-5.

Field 85) Coherence - Array of 512 bins. computed from the complex echoes on the 2 Rx channels field 86. Phase difference - Array of 512 bins. computed from the complex echoes on the 2 Rx channels. Values are in the range -p to +p radians, units are micro radians.

 <p>Advanced Computer Systems</p>		<p><i>Instrument Processing Facility L1b</i></p> <p>Doc. No.: CS-RS-ACS-GS-5106 Issue: 4.0 Date: 10/12/2007 Page: 77</p>
--	---	---

- Deleted: 3
- Deleted: 2
- Deleted: 3
- Deleted: 07

2.3.6 Monitoring MDS Record Structure

Monitoring Products are generated from LRM/TRK – SAR – SARIn and CAL4 (which are included in SARIN) Level 0 data.

All the types of MDS records defined hereafter are provided with the following basic structure:

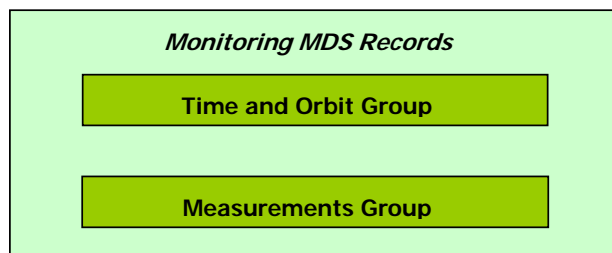

2.3.6.1 LRM/TRK Monitoring MDS Record Structure

For this type of product one type of MDS is defined. The MDS envelopes all the tracking information extracted from TM-LRM or TM-TRK telemetries and copied without conversions or corrections applied in the record structure . The decoded information are geolocated and time tagged.

Field	Description	Units	Bytes	Format
Time and Orbit Group				
1	Data Record Time (MDSR Time Stamp)	TAI	12	sl+2*ul
2	Record counter (always starting from 1)		4	ul
3	Latitude of measurement	10 ⁻¹ μdeg	4	sl (see note 1)
4	Longitude of measurement	10 ⁻¹ μdeg	4	sl (see note 1)
5	Altitude of COG above reference ellipsoid (interpolated value)	mm	4	sl
6	Instantaneous altitude rate derived from orbit	mm/sec	4	sl
7	Spare	-	10*1	uc
8	Monitoring Measurement Confidence Data (flag word)		4	ul (see table 2.3.6.1-2)



Advanced Computer Systems



Instrument Processing Facility L1b

Doc. No.: CS-RS-ACS-GS-5106
 Issue: 4.0
 Date: 10/12/2007
 Page: 78

Deleted: 3

Deleted: 2

Deleted: 3

Deleted: 07

Measurements Group				
9	Source Sequence Count	-	2	us
10	Mode_ID (see Table 2.3.6.1-3)		1	uc
11	Chirp Bandwidth		1	uc
12	Rx Band Attenuation Flag		1	uc
13	Rx Channel Selected		1	uc
14	Loop Command		1	uc
15	Cycle Report		1	uc
16	AGC1	dB	1	uc
17	AGC2	dB	1	uc
18	Altitude command Ho	48.8 ps	4	sl (see note 2)
19	Vertical speed second order COR2	3.05 ps/rc	2	ss (see note 2)
20	Noise Measurement		2	us
21	Tracker Waveform (128 samples)	FFT Power Units	128*2	us
22	Number of TRK Echoes Accumulated		2	us
23	Spare		1	uc
24	CID TRK Packet		1	uc
25	SIRAL_Identifier (0 = Nominal 1 = Redundant)		1	uc
26	Spare		15*1	uc
Total Record Size			340 bytes	

Deleted: 5

Deleted: 6

Table 2.3.6.1-1: LRM/TRK Monitoring Data Product MDS Records

Notes:

1) this is an exotic unit exclusively used at binary record level to improve resolution of the lat and long fields

2) These are exotic units specific of SIRAL instrument

Deleted: exotic

ID	Definition	Bit (*)	Bit (**)	Setting
1.	Block Degraded	31	0	0 = OK 1 = Degraded
2.	Blank Block	30	1	0 = OK 1 = Blank Block inserted for record padding
3.	Datation Degraded	29	2	0 = OK



Advanced Computer Systems



Instrument Processing Facility L1b

Doc. No.: CS-RS-ACS-GS-5106
 Issue: 4.0
 Date: 10/12/2007
 Page: 79

Deleted: 3

Deleted: 2

Deleted: 3

Deleted: 07

				1 = Datation is bad or not set
4.	Orbit Propagation Error	28	3	0 = OK 1 = Error (returned by CFI or independent check)
5.	Orbit File Change	27	4	0 = OK 1 = Orbit file has changed wrt previous record
6.	Orbit Discontinuity	26	5	0 = OK 1 = discontinuity (e.g. gap)
7.	Echo Saturation (from Cycle Report)	25	6	0 = OK 1 = Saturated
8.	Other Echo Error	24	7	0 = OK 1 = Echo Error (bit fields Tracking Echo Error or Echo Rx1 Error or Echo Rx2 Error set to 1)
9.	Rx 1 Channel Error for SARIN	23	8	0 = OK 1 = degraded or missing
10.	Rx 2 Channel error for SARIN	22	9	0 = OK 1 = degraded or missing
11.	Reserved	21-16	10-15	Set to zero
12.	TRK Echo Error	15	16	0 = OK 1 = empty (or null) tracking echo
13.	Echo Rx 1 Error	14	17	0 = OK 1 = empty (or null) raw echo
14.	Echo Rx2 Error	13	18	0 = OK 1 = empty (or null) raw echo
15.	Reserved	12-0	19-31	Set to zero

(*) Ground Segment bit numbering standard [FMT-Guide]

(**) Space Segment bit numbering standard

Table 2.3.6.1-2: Monitoring Data Product MCD



Advanced Computer Systems



Instrument Processing Facility L1b

Doc. No.: CS-RS-ACS-GS-5106
Issue: 4.0
Date: 10/12/2007
Page: 80

- Deleted: 3.
- Deleted: 2
- Deleted: 3
- Deleted: 07

Field Name	Setting
Mode_ID	1 = LRM 2 = SAR 3 = SARIN 33 = CAL3

Table 2.3.6.1-3: Monitoring Data Product Mode_ID Field Definition



Advanced Computer Systems



Instrument Processing Facility L1b

Doc. No.: CS-RS-ACS-GS-5106
 Issue: 4.0
 Date: 10/12/2007
 Page: 81

Deleted: 3

Deleted: 2

Deleted: 3

Deleted: 07

2.3.6.2 SAR Monitoring MDS Record Structure

For this type of product one type of MDS is defined. The MDS envelops all the tracking information extracted from TM-TRK telemetries plus the waveform reconstructed from the 2D FFT processing of the raw echoes contained in the first packet of TM-ECHO-SAR type out of the four that the instrument produces within a tracking cycle. Conversions and instrument corrections are not applied. The decoded information are geolocated and time tagged.

Field	Description	Units	Bytes	Format
Time and Orbit Group				
1	Data Record Time (MDSR Time Stamp)	TAI	12	sl+2*ul
2	Record counter (always starting from 1)		4	ul
3	Latitude of measurement	10 ⁻¹ μdeg	4	sl (see note 1)
4	Longitude of measurement	10 ⁻¹ μdeg	4	sl (see note 1)
5	Altitude of COG above reference ellipsoid (interpolated value)	mm	4	sl
6	Instantaneous altitude rate derived from orbit	mm/sec	4	sl
7	Spare	-	10*1	uc
8	Monitoring Measurement Confidence Data (flag word)		4	ul (see table 2.3.6.1-2)
Measurements Group				
9	Source Sequence Count (from TM-ECHO-SAR)		2	us
10	Mode_ID (see Table 2.3.6.1-3)		1	uc
11	Chirp Bandwidth		1	uc
12	Rx Band Attenuation Flag		1	uc
13	Rx Channel Selected		1	uc
14	Loop Command		1	uc
15	Cycle Report		1	uc
16	AGC1	dB	1	uc
17	AGC2	dB	1	uc
18	Altitude command HO	48.8 ps	4	sl (see note 2)
19	Vertical speed second order HPR	3.05 ps/rc	2	ss (see note 2)
20	Noise Measurement		2	us
21	Tracker Waveform (128 samples)	FFT Power Units	128*2	us
22	Number of TRK Echoes Accumulated		2	us
23	Decimation Factor		2	us

Formatted Table



Advanced Computer Systems



Instrument Processing Facility L1b

Doc. No.: CS-RS-ACS-GS-5106
Issue: 4.0
Date: 10/12/2007
Page: 82

Deleted: 3

Deleted: 2

Deleted: 3

Deleted: 07

24	Normalised 2D Processed Echo SAR (power detected samples stored by doppler beam. 64 doppler beams in total. Each doppler beam contains 64 power detected samples)	FFT Units	Power	64 x 64 x 2	us
25	CID SAR Packet			1	uc
26	CID TRK Packet			1	uc
27	FFT2D Scale Factor	-		4	sl
28	FFT2D Scale Power	-		4	sl
29	SIRAL Identifier (0 = Nominal 1 = Redundant)			1	uc
30	Spare			9*1	uc
Total Record Size				8536 bytes	

Deleted: 29

Deleted: 10

Table 2.3.6.2-1: SAR Monitoring Data Product MDS Records

Notes:

1) this is an exotic unit exclusively used at binary record level to improve resolution of the lat and long fields

2) These are exotic units specific of SIRAL instrument

Deleted: exotic



Advanced Computer Systems



Instrument Processing Facility L1b

Doc. No.: CS-RS-ACS-GS-5106
 Issue: 4.0
 Date: 10/12/2007
 Page: 83

Deleted: 3.

Deleted: 2

Deleted: 3

Deleted: 07

2.3.6.3 SARIN Monitoring MDS Record Structure

For this type of product one type of MDS is presently defined. The MDS envelopes all the tracking information extracted from TM-TRK telemetries plus the waveform reconstructed from a simple 2D FFT processing of the raw echoes contained in the first packet of TM-ECHO-SARIN type out of the four that the instrument produces within a tracking cycle. Conversions or instrument corrections are not applied. The decoded information are geolocated and time tagged.

Field	Description	Units	Bytes	Format
Time and Orbit Group				
1	Data Record Time (MDSR Time Stamp)	TAI	12	sl+2*ul
2	Record counter (always starting from 1)		4	ul
3	Latitude of measurement	10 ⁻¹ μdeg	4	sl (see note 1)
4	Longitude of measurement	10 ⁻¹ μdeg	4	sl (see note 1)
5	Altitude of COG above reference ellipsoid (interpolated value)	mm	4	sl
6	Instantaneous altitude rate derived from orbit	mm/sec	4	sl
7	Spare		10*1	uc
8	Monitoring Measurement Confidence Data (flag word)		4	ul (see table 2.3.6.1-2)
Measurements Group				
9	Source Sequence Count (From TM-ECHO-SARIN Master Ch)		2	us
10	Mode_ID (see Table 2.3.6.1-3)		1	uc
11	Chirp Bandwidth		1	uc
12	Rx Band Attenuation Flag		1	uc
13	Rx Channel Selected		1	uc
14	Loop Command		1	uc
15	Cycle Report		1	uc
16	AGC1	dB	1	uc
17	AGC2	dB	1	uc
18	Altitude command HO	48.8 ps	4	sl (see note 2)
19	Vertical speed second order HPR	3.05 ps/rc	2	ss (see note 2)
20	Noise Measurement		2	us
21	Tracker Waveform (128 samples)	FFT Power Units	128*2	us
22	Number of TRK Echoes Accumulated		2	us
23	Decimation Factor		2	us



Advanced Computer Systems



Instrument Processing Facility L1b

Doc. No.: CS-RS-ACS-GS-5106
 Issue: 4.0
 Date: 10/12/2007
 Page: 84

Deleted: 3.

Deleted: 2

Deleted: 3

Deleted: 07

24	Normalised 2D Processed Echo SAR from Rx 1 Channel (power detected samples stored by doppler beam. 64 doppler beams in total. Each doppler beam contains 64 power detected samples)	FFT Power Units	64 x 64 x 2	us
25	Normalised 2D Processed Echo SAR from Rx 2 Channel (power detected samples stored by doppler beam. 64 doppler beams in total. Each doppler beam contains 64 power detected samples)	FFT Power Units	64 x 64 x 2	us
26	CID SARIN Packet Rx1 Channel		1	uc
27	CID SARIN Packet Rx 2 Channel		1	uc
28	SIRAL Identifier (0 = Nominal 1 = Redundant)		<u>1</u>	<u>uc</u>
29	CID TRK Packet		1	uc
30	FFT2D Scale Factor for Rx1 Channel	-	4	sl
31	FFT2D Scale Power for Rx1 Channel	-	4	sl
32	FFT2D Scale Factor for Rx2 Channel	-	4	sl
33	FFT2D Scale Power for Rx2 Channel	-	4	sl
Total Record Size			16728 bytes	

Deleted: 28

... [1]

Table 2.3.6.3-1: SARIN Monitoring Data Product MDS Record

Notes:

1) this is an exotic unit exclusively used at binary record level to improve resolution of the lat and long fields

2) These are exotic units specific of SIRAL instrument

Deleted: exotic



Advanced Computer Systems



Instrument Processing Facility L1b

Doc. No.: CS-RS-ACS-GS-5106
 Issue: 4.0
 Date: 10/12/2007
 Page: 85

Deleted: 3.

Deleted: 2

Deleted: 3

Deleted: 07

2.3.6.4 CAL4 Monitoring MDS Record Structure

An objective of the Monitoring applied to SARIn data is to provide information extracted from CAL4 packets. CAL 4 information are provided every 20 (TBC) tracking cycles. This product is then suited to exclusively collect the CAL 4 data found in the input Level 0 data stream. CAL4 data are maintained in their raw format, i.e. specific processing is not applied.

The decoded information are geolocated and time tagged.

Field	Description	Units	Bytes	Format
Time and Orbit Group				
1	Data Record Time (MDSR Time Stamp)	TAI	12	sl+2*ul
2	Record counter (always starting from 1)		4	ul
3	Latitude of measurement	10 ⁻¹ μdeg	4	sl (see note 1)
4	Longitude of measurement	10 ⁻¹ μdeg	4	sl (see note 1)
5	Altitude of COG above reference ellipsoid (interpolated value)	mm	4	ul
6	Instantaneous altitude rate derived from orbit	mm/sec	4	sl
7	Spare		10*1	uc
8	Monitoring Measurement Confidence Data (flag word)		4	ul (see table 2.3.6.1-2)
Measurements Group				
9	Source Sequence Count (from TM-ECHO-SARIN Master ch)		2	us
10	Mode_ID (see Table 2.3.6.1-3)		1	uc
11	Chirp Bandwidth		1	uc
12	Rx Band Attenuation Flag		1	uc
13	Rx Channel Selected		1	uc
14	Loop Command		1	uc
15	Cycle Report		1	uc
16	AGC1	dB	1	uc
17	AGC2	dB	1	uc
18	Altitude command HO	48.8 ps	4	sl (see note 2)
19	Vertical speed second order HPR	3.05 ps/rc	2	ss (see note 2)
20	Noise Measurement		2	us
21	CAL4 complex data from Rx 1 Channel [64, 512, 2]	-	64*512*2	sc
22	CAL4 complex data from Rx 2 Channel [64, 512, 2]	-	64*512*2	sc



Advanced Computer Systems



Instrument Processing Facility L1b

Doc. No.: CS-RS-ACS-GS-5106
Issue: 4.0
Date: 10/12/2007
Page: 86

Deleted: 3

Deleted: 2

Deleted: 3

Deleted: 07

23	CID SARIN Packet Rx1 Channel		1	uc
24	CID SARIN Packet Rx 2 Channel		1	uc
25	Spare		1	uc
26	CID TRK Packet		1	uc
27	SIRAL Identifier (0 = Nominal 1 = Redundant)		<u>1</u>	<u>uc</u>
28	Spare		<u>15</u> *1	uc
Total Record Size			131156 bytes	

Deleted: 7

Deleted: 16

Table 2.3.6.3-1: CAL4 Monitoring Data Product MDS Record

Notes:

1) this is an exotic unit exclusively used at binary record level to improve resolution of the lat and long fields

2) These are exotic units specific of SIRAL instrument

Deleted: exotic

 <p>Advanced Computer Systems</p>		<p><i>Instrument Processing Facility L1b</i></p> <p>Doc. No.: CS-RS-ACS-GS-5106 Issue: 4.0 Date: 10/12/2007 Page: 87</p>
--	---	---

- Deleted: 3
- Deleted: 2
- Deleted: 3
- Deleted: 07

2.3.7 Cal1 MDS Record Structures

Cal1 nominal Products are characterised by multiple record types (types 1 and 2) which are specific for the three possible calibration types in CAL1 Mode: LRM – SAR – SARIn.

All the types of MDS records defined hereafter are provided with the following basic structure:

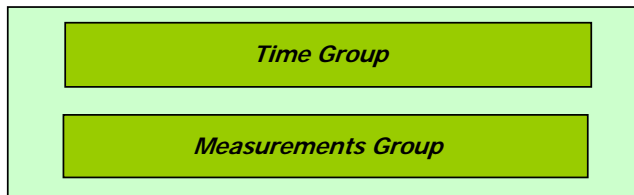

As minimum a product will be constituted by one MDS of the first type (described in the following sections) which contains the whole bunch of results of the calibration processing applied to an individual CAL1 level 0 file supplied in input and one MDS of the second type containing the calibration corrections (i.e. range and gain) and the associated MDSR time stamp.

Actually CAL 1 products may be generated starting from more than one Level 0 product. This possibility implies that in the product there will be as many MDS of the first type for as many CAL 1 Level 0 files supplied in input and a set of MDS of the second type containing interpolated calibration corrections with their associated time stamp.

There is actually a fourth type of calibration product which is generated from the special processing of the CAL1-SARIN exotic data (i.e. with AGC and Frequency Synthesiser Stepping Command). This product is still characterised by a single MDS.

2.3.7.1 Cal1 LRM MDS Record Structures

The first type of MDS contains the reconstructed PTR measurements and the results of the processing applied to the reconstructed PTR.

Field	Description	Units	Bytes	Format
Time Group				
1	Data Record Time (MDSR Time Stamp)	TAI	12	sl+2*ul
2	USO Correction Factor	10-9	4	sl
3	Mode ID		2	us
4	Spare		2*1	uc
5	Instrument Configuration		4	ul



Advanced Computer Systems



Instrument Processing Facility L1b

Doc. No.: CS-RS-ACS-GS-5106
 Issue: 4.0
 Date: 10/12/2007
 Page: 88

Deleted: 3.

Deleted: 2

Deleted: 3

Deleted: 07

6	Record Counter (always starting from 1)		4	ul
7	Latitude of measurement	10^{-1} μ deg	4	sl (see note 1)
8	Longitude of measurement	10^{-1} μ deg	4	sl (see note 1)
9	Altitude of COG above reference ellipsoid (interpolated value)	mm	4	sl
10	Instantaneous altitude rate derived from orbit	mm/sec	4	sl
11	CAL1 Measurement Confidence Data (flag word)		4	ul see table 2.3.7.1-2
Measurements Group				
12	Normalised Point Target Response Samples (P*128) (P in range 1..64) (max 8192 samples)	-	8192*2	us
13	AGC (AGC_1 + AGC_2) Corrected	dB/100	4	sl (see note 3)
14	Tx-Rx Power*Gain Variation	dB/100	4	sl (see note 3)
15	Tx-Rx LO Differential Path delay (one way delay)	ps	4	sl
16	PSLR	dB/100	4	sl (see note 3)
17	3 dB Width	ps	4	sl
18	AGC_1 Command	dB/100	4	sl (see note 3)
19	AGC_2 Command	dB/100	4	sl (see note 3)
20	PTR Scale Factor	-	4	sl
21	PTR Scale Power	-	4	sl
22	Spare		4*1	uc
Total Record Size			16472 bytes	

Table 2.3.7.1-1: Cal1 LRM MDS Records (Type 1)

Notes:

1) this is an exotic unit exclusively used at binary record level to improve resolution of the lat and long fields

3) This is an exotic unit used for db-units related fields.



Advanced Computer Systems



Instrument Processing Facility L1b

Doc. No.: CS-RS-ACS-GS-5106
 Issue: 4.0
 Date: 10/12/2007
 Page: 89

Deleted: 3

Deleted: 2

Deleted: 3

Deleted: 07

ID	Definition	Bit (*)	Bit (**)	Setting
1.	CAL Error	31	0	0 = Valid Record 1 = Invalid Record
2.	Reserved	30-28	1-3	Set to zero
3	Cal1 Correction Missing	27	4	0 = correction applied 1 = correction not applied
4	Complex Cal1 Correction from IPF DB	26	5	0 = correction from Complex CAL1 Product used 1 = correction from IPF DB used
5.	AGC Inconsistency	25	6	0 = OK (AGC is static) 1 = AGC Stepping detected
6.	Reserved	24	7	Set to zero
7.	PTR Computation Error	23	8	0 = Average PTR computed 1 = Error (not available)
8.	Cal2 Correction Missing	22	9	0 = correction applied to PTR 1 = correction not applied
9.	Cal 2 Correction from IPF DB	21	10	0 = correction from CAL1 Product used 1 = correction from IPF DB used
10.	DORIS USO Correction	20	11	0 = USO Correction Factor is available 1 = USO Correction Factor is not available
11.	PTR Analysis Method	19	12	0 = Gauss Fitting 1 = Search for Maximum
12.	PTR Width Error	18	13	0 = OK 1 = Error (width is out of range)
13.	PTR PSLR Error	17	14	0 = OK 1 = Error (PSLR is out of range)
14.	Gain Correction Error	16	15	0 = OK 1 = Error (value out of range)

 Advanced Computer Systems		Instrument Processing Facility L1b	
		Doc. No.:	CS-RS-ACS-GS-5106
		Issue:	4.0
		Date:	10/12/2007
		Page:	90

- Deleted: 3
- Deleted: 2
- Deleted: 3
- Deleted: 07

15.	Delay Correction Error	15	16	0 = OK 1 = Error (value out of range)
16	Reserved	14	17-31	Set to zero

(*) Ground Segment bit numbering standard [FMT-Guide]

(**) Space Segment bit numbering standard

Table 2.3.7.1-2: CAL1-LRM MCD

The second type of MDS contains the interpolated corrections derived from the individual measurements:

Field	Description	Units	Bytes	Format
Time Group				
1	Data Record Time	TAI	12	sl+2*ul
2	Error Flag 0 = Valid Measurement 1 = Not Valid Measurement		4	ul
3	Record Counter (always starting from 1)		4	ul
4	Spares		4*1	uc
Measurements Group				
5	Tx-Rx Power*Gain Variation (interpolated value)	dB/100	4	sl (see note 3)
6	Tx-Rx LO Differential Path delay (interpolated value – one way delay)	ps	4	sl
7	Spare		12*1	uc
Total Record Size			44 bytes	

Table 2.3.7.1-3: Cal1 LRM MDS Records (Type 2)

Notes:

3) This is an exotic unit used for db-units related fields.



Advanced Computer Systems



Instrument Processing Facility L1b

Doc. No.: CS-RS-ACS-GS-5106
 Issue: 4.0
 Date: 10/12/2007
 Page: 91

Deleted: 3.

Deleted: 2

Deleted: 3

Deleted: 07

2.3.7.2 Cal1 SAR MDS Record Structures

The first type of MDS record contains the results of the elaborations required to provide the average RiRs (Range Impulse Response) and the average AiR (Azimuth Impulse Response), both zero padded by a factor of 64, as well as auxiliary information, like the average phase correction, the range and gain corrections and quality parameters.

Deleted: s

Field	Description	Units	Bytes	Format
Time Group				
1	Data Record Time (MDSR Time Stamp)	TAI	12	sl+2*ul
2	USO Correction Factor	10-9	4	sl
3	Mode ID		2	us
4	Spare		2*1	uc
5	Instrument Configuration		4	ul
6	Record counter (always starting from 1)		4	ul
7	Latitude of measurement	10 ⁻¹ μdeg	4	sl (see note 1)
8	Longitude of measurement	10 ⁻¹ μdeg	4	sl (see note 1)
9	Altitude of COG above reference ellipsoid (interpolated value)	mm	4	sl
10	Instantaneous altitude rate derived from orbit	mm/sec	4	sl
11	CAL1 Measurement Confidence Data (flag word)		4	ul see table 2.3.7.1-2
Measurements Group				
12	Normalised Power Detected PTR (8192 samples: zero padded by factor of 64)	-	8192*2	us
13	AGC (AGC_1+AGC_2) Corrected	dB/100	4	sl (see note 3)
14	Tx-Rx Power*Gain Variation	dB/100	4	sl (see note 3)
15	Tx-Rx LO Differential Path delay (one way delay)	ps	4	sl
16	RiR PSLR	dB/100	4	sl (see note 3)
17	RiR 3 dB Width	ps	4	sl
18	Pulse to Pulse Phase Correction Curve (64 samples)	micro-radians	64*4	sl
19	Pulse to Pulse Amplitude Correction Curve (64 samples)	10 ⁻⁶	64*4	sl
20	AGC_1 Command	dB/100	4	sl (see note 3)
21	AGC_2 Command	dB/100	4	sl (see note 3)
22	PTR Scale Factor	-	4	sl

 Advanced Computer Systems		Instrument Processing Facility L1b	
		Doc. No.:	CS-RS-ACS-GS-5106
		Issue:	4.0
		Date:	10/12/2007
		Page:	92

- Deleted: 3.
- Deleted: 2
- Deleted: 3
- Deleted: 07

23	PTR Scale Power	-	4	sl
24	Spares		12*1	uc
Total Record Size			16992 bytes	

Table 2.3.7.2-1 : CAL1 SAR MDS Record (Type 1)

Notes:

- 1) this is an exotic unit exclusively used at binary record level to improve resolution of the lat and long fields
- 3) This is an exotic unit used for db-units related fields.

ID	Definition	Bit (*)	Bit (**)	Setting
1.	CAL Error	31	0	0 = Valid Record 1 = Invalid Record
2.	Reserved	30-28	1-3	Set to zero
3	Cal1 Correction Missing	27	4	0 = correction applied 1 = correction not applied
4	AUTO Cal1 Correction from IPF DB	26	5	0 = correction from Complex CAL1 Product used 1 = correction from IPF DB used
5.	AGC Inconsistency	25	6	0 = OK (AGC is static) 1 = AGC Stepping detected
6.	Frequency Synthesiser Inconsistency	24	7	0 = OK (Freq. Synth Command is static) 1 = Freq. Synth. Comd. Stepping detected
7.	PTR Computation Error	23	8	0 = Average PTR computed 1 = Error (not available)
8.	Cal2 Correction Missing	22	9	0 = correction applied to PTR 1 = correction not applied
9.	Cal 2 Correction from IPF DB	21	10	0 = correction from CAL1 Product used 1 = correction from IPF DB used
10.	DORIS USO Correction	20	11	0 = USO Correction Factor is available 1 = USO Correction Factor is not available
11.	PTR Analysis Method	19	12	0 = Gauss Fitting 1 = Search for Maximum

Deleted: 3
Deleted: 2
Deleted: 3
Deleted: 07

12.	PTR Width Error	18	13	0 = OK 1 = Error (width is out of range)
13.	PTR PSLR Error	17	14	0 = OK 1 = Error (PSLR is out of range)
14.	Gain Correction Error	16	15	0 = OK 1 = Error (value out of range)
15.	Delay Correction Error	15	16	0 = OK 1 = Error (value out of range)
16.	Burst Correction Error	14	17	0 = OK 1 = Error (not computed)
17.	Reserved	13-0	18-31	Set to zero

(*) Ground Segment bit numbering standard [FMT-Guide]

(**) Space Segment bit numbering standard

Table 2.3.7.1-2: CAL1-SAR MCD

The second type of MDS contains the interpolated corrections derived from the individual measurements:

Field	Description	Units	Bytes	Format
Time Group				
1	Data Record Time	TAI	12	sl+2*ul
2	Error Flag 0 = Valid Measurement 1 = Not Valid Measurement		4	ul
3	Record Counter (always starting from 1)		4	ul
4	Spares		4*1	uc
Measurements Group				
5	Tx-Rx Power*Gain Variation (interpolated value)	dB/100	4	sl (see note 3)
6	Tx-Rx LO Differential Path delay (interpolated value – one way delay)	ps	4	sl
7	Pulse to Pulse Phase Correction Curve (64 samples: interpolated values)	micro-radians	64*4	sl
8	Pulse to Pulse Amplitude Correction Curve (64 samples: interpolated values)	10 ⁻⁶	64*4	sl

 <p>Advanced Computer Systems</p>		<p><i>Instrument Processing Facility L1b</i></p> <p>Doc. No.: CS-RS-ACS-GS-5106 Issue: 4.0 Date: 10/12/2007 Page: 94</p>
--	---	---

- Deleted: 3
- Deleted: 2
- Deleted: 3
- Deleted: 07

9	Spare		12*1	uc
Total Record Size			556 bytes	

Table 2.3.7.2-3 : CAL1 SAR MDS Record (Type 2)

Notes:

3) This is an exotic unit used for dB-units related fields.



Advanced Computer Systems



Instrument Processing Facility L1b

Doc. No.: CS-RS-ACS-GS-5106
 Issue: 4.0
 Date: 10/12/2007
 Page: 95

Deleted: 3.

Deleted: 2

Deleted: 3

Deleted: 07

2.3.7.3 Cal1 SARIn MDS Record Structures

The first type of MDS record contains the results of the elaborations required to provide a set of 64 RiRs (Range Impulse Response) and the average AiR (Azimuth Impulse Response), both zero padded by a factor of 64, for each Rx channel as well as auxiliary information, like the average phase correction, the range and gain corrections and quality parameters.

Deleted: s

Field	Description	Units	Bytes	Format
Time Group				
1	Data Record Time (MDSR Time Stamp)	TAI	12	sl+2*ul
2	USO Correction Factor		4	sl
3	Mode ID		2	us
4	Spare		2*1	uc
5	Instrument Configuration		4	ul
6	Record counter (always starting from 1)		4	ul
7	Latitude of measurement	10^{-1} μ deg	4	sl (see note 1)
8	Longitude of measurement	10^{-1} μ deg	4	sl (see note 1)
9	Altitude of COG above reference ellipsoid (interpolated value)	mm	4	sl
10	Instantaneous altitude rate derived from orbit	mm/sec	4	sl
11	CAL1 Measurement Confidence Data (flag word)		4	ul see table 2.3.7.3-2
Measurements Group				
Rx 1 Channel: Retrieved Parameters				
12	Normalised Power Detected PTR of Rx1 Channel (8192 samples: zero padded by factor of 16)	-	8192*2	us
13	AGC (AGC_1 + AGC_2) Corrected of Rx1 Channel	dB/100	4	sl (see note 3)
14	Tx-Rx Power*Gain Variation of Rx1 Channel	dB/100	4	sl (see note 3)
15	Tx-Rx LO Differential Path delay of Rx1 Channel (one way delay)	ps	4	sl
16	PTR PSLR	dB/100	4	sl (see note 3)
17	PTR 3 dB Width	ps	4	sl
18	Pulse to Pulse Phase Correction Curve (64 samples) of Rx 1 Channel	Micro-radians	64*4	sl
19	Pulse to Pulse Amplitude Correction Curve (64 samples) of Rx 1 Channel	10^{-6}	64*4	sl
20	Rx1 PTR Scale Factor	-	4	sl
21	Rx1 PTR Scale Power	-	4	sl



Advanced Computer Systems



Instrument Processing Facility L1b

Doc. No.: CS-RS-ACS-GS-5106
 Issue: 4.0
 Date: 10/12/2007
 Page: 96

Deleted: 3

Deleted: 2

Deleted: 3

Deleted: 07

22	Spare		12*1	uc
Rx 2 Channel: Retrieved Parameters				
23	Normalised Power Detected PTR of Rx2 channel (8192 samples: zero padded by factor of 16)	-	8192*2	us
24	AGC (AGC_1 + AGC_2) Corrected of Rx2 Channel	dB/100	4	sl (see note 3)
25	Tx-Rx Power*Gain Variation of Rx2 Channel	dB/100	4	sl (see note 3)
26	Tx-Rx LO Differential Path delay of Rx2 Channel (one way delay)	ps	4	sl
27	RiR PSLR	dB/100	4	sl (see note 3)
28	RiR 3 dB Width	ps	4	sl
29	Pulse to Pulse Phase Correction Curve (64 samples) of Rx 2 Channel	Micro-radians	64*4	sl
30	Pulse to Pulse Amplitude Correction Curve (64 samples) of Rx 2 Channel	10 ⁻⁶	64*4	sl
31	Rx2 PTR Scale Factor	-	4	sl
32	Rx2 PTR Scale Power	-	4	sl
33	Spare		12*1	uc
Phase and Amplitude of Rx1 and Rx2 (extracted from RiR peaks)				
34	Phase PTR Peak Rx 1	Micro-radians	4	sl
35	Amplitude PTR Peak Rx 1	10 ⁻⁶	4	sl
36	Phase RiR Peak Rx 2	Micro-radians	4	sl
37	Amplitude RiR Peak Rx 2	10 ⁻⁶	4	sl
Common Rx1 and Rx2 Instrument Commands				
38	AGC_1 Command	dB/100	4	sl
39	AGC_2 Command	dB/100	4	sl
40	Frequency Synthesiser Command	-	2	us
41	Spares		10*1	uc
Total Record Size			33956 bytes	

Table 2.3.7.3-1 : CAL1 SARIn MDS Record (Type 1)

Notes:

- 1) this is an exotic unit exclusively used at binary record level to improve resolution of the lat and long fields
- 3) This is an exotic unit used for dB-units related fields.



Advanced Computer Systems



Instrument Processing Facility L1b

Doc. No.: CS-RS-ACS-GS-5106
 Issue: 4.0
 Date: 10/12/2007
 Page: 97

Deleted: 3

Deleted: 2

Deleted: 3

Deleted: 07

ID	Definition	Bit (*)	Bit (**)	Setting
1.	CAL Error	31	0	0 = Valid Record 1 = Invalid Record (logical AND between CAL_Rx1_error and CAL_Rx2_error)
2.	CAL Rx 1 Error	30	1	0 = Rx1 related corrections valid 1 = Rx1 related corrections not valid
3.	CAL Rx 1 Error	29	2	0 = Rx1 related corrections valid 1 = Rx1 related corrections not valid
4.	Reserved	28	3	Set to zero
5	Cal1 Correction Missing	27	4	0 = correction applied 1 = correction not applied
6	Complex Cal1 Correction from IPF DB	26	5	0 = correction from Complex CAL1 Product used 1 = correction from IPF DB used
7.	AGC Inconsistency	25	6	0 = OK (AGC is static) 1 = AGC Stepping detected
8.	Frequency Synthesiser Inconsistency	24	7	0 = OK (Freq. Synth Command is static) 1 = Freq. Synth. Comd. Stepping detected
9.	PTR Computation Rx1 Error	23	8	0 = Average PTR from Rx1 computed 1 = Error (not available)
10.	PTR Computation Rx2 Error	22	9	0 = Average PTR from Rx2 computed 1 = Error (not available)
11.	Cal2 Correction Missing	21	10	0 = correction applied to PTR 1 = correction not applied
12.	Cal 2 Rx 1 Correction from IPF DB	20	11	0 = correction from CAL1 Rx1 Product used 1 = correction from IPF DB used
13.	Cal 2 Rx 2 Correction from IPF DB	19	12	0 = correction from CAL1 Rx2 Product used 1 = correction from IPF DB used
14.	DORIS USO Correction	18	13	0 = USO Correction Factor is available 1 = USO Correction Factor is not



Advanced Computer Systems



Instrument Processing Facility L1b

Doc. No.: CS-RS-ACS-GS-5106
Issue: 4.0
Date: 10/12/2007
Page: 98

Deleted: 3

Deleted: 2

Deleted: 3

Deleted: 07

				available
15.	PTR Analysis Method	17	14	0 = Gauss Fitting 1 = Search for Maximum
16.	PTR Width Rx1 Error	16	15	0 = OK 1 = Error (width is out of range)
17.	PTR Width Rx2 Error	15	16	0 = OK 1 = Error (width is out of range)
18.	PTR PSLR Rx1 Error	14	17	0 = OK 1 = Error (PSLR is out of range)
19.	PTR PSLR Rx2 Error	13	18	0 = OK 1 = Error (PSLR is out of range)
20.	Gain Correction Rx1 Error	12	19	0 = OK 1 = Error (value out of range)
21.	Delay Correction Rx1 Error	11	20	0 = OK 1 = Error (value out of range)
22.	Gain Correction Rx2 Error	10	21	0 = OK 1 = Error (value out of range)
23.	Delay Correction Rx2 Error	9	22	0 = OK 1 = Error (value out of range)
24.	Burst Rx1 Correction Error	8	23	0 = OK 1 = Error (not computed)
25.	Burst Rx2 Correction Error	7	24	0 = OK 1 = Error (not computed)
26.	Reserved	6-0	25-31	Set to zero

(*) Ground Segment bit numbering standard [FMT-Guide]

(**) Space Segment bit numbering standard

Table 2.3.7.3-2: CAL1-SARIN MCD



Advanced Computer Systems



Instrument Processing Facility L1b

Doc. No.: CS-RS-ACS-GS-5106
 Issue: 4.0
 Date: 10/12/2007
 Page: 99

Deleted: 3

Deleted: 2

Deleted: 3

Deleted: 07

The second type of MDS contains the interpolated corrections derived from the individual measurements:

Field	Description	Units	Bytes	Format
Time Group				
1	Data Record Time	TAI	12	sl+2*ul
2	Error Flag 0 = Valid Measurement 1 = Not Valid Measurement		4	ul
3	Record Counter (always starting from 1)		4	ul
4	Spares		4*1	uc
Measurements Group				
5	Tx-Rx Power*Gain Variation (interpolated value) of Rx 1 Channel	dB/100	4	sl (see note 3)
6	Tx-Rx LO Differential Path delay (interpolated value – one way delay) of Rx 1 Channel	ps	4	sl
7	Pulse to Pulse Phase Correction Curve (64 samples: interpolated values) of Rx 1 Channel	Micro-radians	64*4	sl
8	Pulse to Pulse Amplitude Correction Curve (64 samples: interpolated values) of Rx 1 Channel	10 ⁻⁶	64*4	sl
9	Tx-Rx Power*Gain Variation (interpolated value) of Rx 2 Channel	dB/100	4	sl (see note 3)
10	Tx-Rx LO Differential Path delay (interpolated value – one way delay) of Rx 2 Channel	ps	4	sl
11	Pulse to Pulse Phase Correction Curve (64 samples: interpolated values) of Rx 2 Channel	Micro-radians	64*4	sl
12	Pulse to Pulse Amplitude Correction Curve (64 samples: interpolated values) of Rx 2 Channel	10 ⁻⁶	64*4	sl
13	Phase RiR Peak Rx 1 (interpolated value)	Micro-radians	4	sl
14	Amplitude RiR Peak Rx 1 (interpolated value)	10 ⁻⁶	4	sl
15	Phase RiR Peak Rx 2 (interpolated value)	Micro-radians	4	sl
16	Amplitude RiR Peak Rx 2 (interpolated value)	10 ⁻⁶	4	sl
17	Spare		12*1	uc
Total Record Size			1092 bytes	

Table 2.3.7.3-3 : CAL1 SARIn MDS Record (Type 2)



Advanced Computer Systems



Instrument Processing Facility L1b

Doc. No.: CS-RS-ACS-GS-5106
Issue: 4.0
Date: 10/12/2007
Page: 100

Deleted: 3.

Deleted: 2

Deleted: 3

Deleted: 07

Notes:

3) This is an exotic unit used for db-units related fields.



Advanced Computer Systems



Instrument Processing Facility L1b

Doc. No.: CS-RS-ACS-GS-5106
 Issue: 4.0
 Date: 10/12/2007
 Page: 101

Deleted: 3.

Deleted: 2

Deleted: 3

Deleted: 07

2.3.7.4 AUTO CAL1-SARIN MDS Record

Field	Description	Units	Size (Bytes)	Format
Time Group				
1	Data record time	TAI	12	sl+2*ul
2	USO correction factor	10 ⁻⁹	4	sl
3	Mode ID	N/A	2	us
4	spare		2	us
5	Instrument config	N/A	4	ul
6	Record count		4	sl
7	latitude	10 ⁻⁷ Deg	4	sl (see note 1)
8	longitude	10 ⁻⁷ Deg	4	sl (see note 1)
Measurement Group				
9	Calibrated AGC1 chain 1 (32 combinations)	dB/100	128	sl (see note 3)
10	Calibrated AGC1 chain 2 (32 combinations)	dB/100	128	sl (see note 3)
11	Calibrated AGC2 chain 1 (32 combinations)	dB/100	128	sl (see note 3)
12	Calibrated AGC2 chain 2 (32 combinations)	dB/100	128	sl (see note 3)
13	Calibrated AGC command table (63 Commands) chain 1	dB/100	252	sl (see note 3)
14	Calibrated AGC measurement command table chain 2	dB/100	252	sl (see note 3)
15	Inversion quality chain 1 (AGC cal)	TBD	4	sl
16	Inversion quality chain 2 (AGC cal)	TBD	4	sl
17	Phase difference curves 32*11 AGC 1 settings	10 ⁻⁶ Rad	1408	sl
18	Phase difference curves 32*11 AGC 2 settings	10 ⁻⁶ Rad	1408	sl
19	Frequency interpolated (512 points) phase difference curves 63*512 for all AGC measurement command table settings	10 ⁻⁶ Rad	129024	sl
20	Inversion quality at 11 frequencies (Phase difference cal)	TBD	44	sl
21	MCD (see table 2.37.4-2)	-	4	ul
	TOTAL		132948	

Table 2.3.7.4-1 : CAL1 SARIn Exotic MDS Record

- 1) this is an exotic unit exclusively used at binary record level to improve resolution of the lat and long fields
- 3) This is an exotic unit used for dB-units related fields.



Advanced Computer Systems



Instrument Processing Facility L1b

Doc. No.: CS-RS-ACS-GS-5106
Issue: 4.0
Date: 10/12/2007
Page: 102

Deleted: 3.

Deleted: 2

Deleted: 3

Deleted: 07

ID	Definition	Bit (*)	Bit (**)	Setting
1.	CAL Error	31	0	0 = Valid Record 1 = Invalid Record
2.	Reserved	7-30	1-24	Set to zero
3.	Auto CAL-1 Attenuator calibrated	6	25	0= Calibrated 1=not calibrated
4.	Gain inversion matrix condition greater than threshold	5	26	0 = OK 1=threshold exceeded
5.	Phase difference matrix condition greater then threshold	4	27	0 = OK 1=threshold exceeded
6.	reserved	3-0	28-31	Set to zero

Table 2.3.7.3-2: CAL1-SARIN Exotic MCD



Advanced Computer Systems



Instrument Processing Facility L1b

Doc. No.: CS-RS-ACS-GS-5106
 Issue: 4.0
 Date: 10/12/2007
 Page: 103

Deleted: 3.

Deleted: 2

Deleted: 3

Deleted: 07

2.3.8 Cal2 MDS Record Structure

Cal2 Products are characterised by multiple record types which are specific for the two possible calibration types in CAL2 Mode: SAR – SARIn.

The MDS structures are based on the [MSL-PS] documents with amendments and corrections as identified at present.

2.3.8.1 Cal2 SAR MDS Record Structure

Field	Description	Units	Bytes	Format
Time Group				
1	Data Record Time (MDSR Time Stamp)	TAI	12	sl+2*ul
2	USO Correction Factor		4	sl
3	Mode ID		2	us
4	Spare		2*1	uc
5	Instrument Configuration		4	ul
6	Record counter (fixed to 1)		4	ul
7	Latitude of measurement	10 ⁻¹ μdeg	4	sl (see note 1)
8	Longitude of measurement	10 ⁻¹ μdeg	4	sl (see note 1)
9	Altitude of COG above reference ellipsoid (interpolated value)	mm	4	sl
10	Instantaneous altitude rate derived from orbit	mm/sec	4	sl
11	CAL2 Measurement Confidence Data (flag word)		4	ul (see table 2.3.8.1-2)
Measurements Group				
12	LPF Filter Shape Correction Mask(128 power samples)	10 ⁻⁶	128*4	sl
13	Number of Noise Spectra averaged		4	ul
14	AGC (AGC_1 + AGC_2) Corrected	dB/100	4	sl (see note 3)
15	AGC_1 Command	dB/100	4	sl (see note 3)
16	AGC_2 Command	dB/100	4	sl (see note 3)
17	Number of Spikes from AUX_SIRDBF	-	2	us
18	Number of Spikes autodetected	-	2	us
19	Spare		16*1	uc
Total Size			596 bytes	

Table 2.3.8.1-1: Cal 2 SAR MDS Record Structure

 <p>Advanced Computer Systems</p>		<p><i>Instrument Processing Facility L1b</i></p> <p>Doc. No.: CS-RS-ACS-GS-5106 Issue: 4.0 Date: 10/12/2007 Page: 104</p>
--	---	--

- Deleted: 3
- Deleted: 2
- Deleted: 3
- Deleted: 07

Notes:

- 1) this is an exotic unit exclusively used at binary record level to improve resolution of the lat and long fields
- 3) This is an exotic unit used for db-units related fields.

ID	Definition	Bit (*)	Bit (**)	Setting
1.	CAL Error	31	0	0 = Valid Record 1 = Invalid Record
2.	Reserved	30-28	1-3	Set to zero
3	Cal1 Correction Missing	27	4	0 = correction applied 1 = correction not applied
4	Complex Cal1 Correction from IPF DB	26	5	0 = correction from Complex CAL1 Product used 1 = correction from IPF DB used
5.	AGC Inconsistency	25	6	0 = OK (AGC is static) 1 = AGC Stepping detected
6.	Noise Spectra Computation Error	24	7	0 = OK 1 = Error (some spectra were not computed)
7.	Noise Power Error	23	8	0 = OK 1 = Mean Noise Power out of Range
8.	Reserved	22-0	9-31	Set to zero

- (*) Ground Segment bit numbering standard [FMT-Guide]
- (**) Space Segment bit numbering standard

Table 2.3.8.1-2: CAL2 MCD



Advanced Computer Systems



Instrument Processing Facility L1b

Doc. No.: CS-RS-ACS-GS-5106
 Issue: 4.0
 Date: 10/12/2007
 Page: 105

Deleted: 3.

Deleted: 2

Deleted: 3

Deleted: 07

2.3.8.2 Cal 2 SARIn MDS Record Structure

Field	Description	Units	Bytes	Format
Time Group				
1	Data Record Time (MDSR Time Stamp)	TAI	12	sl+2*ul
2	USO Correction Factor		4	sl
3	Mode ID		2	us
4	Spare		2*1	uc
5	Instrument Configuration		4	ul
6	Record counter (fixed to 1)		4	ul
7	Latitude of measurement	10 ⁻¹ μdeg	4	sl (see note 1)
8	Longitude of measurement	10 ⁻¹ μdeg	4	sl (see note 1)
9	Altitude of COG above reference ellipsoid (interpolated value)	mm	4	sl
10	Instantaneous altitude rate derived from orbit	mm/sec	4	sl
11	CAL2 Measurement Confidence Data (flag word)		4	ul (see Table 2.3.8.1-2)
Measurements Group				
12	LPF Filter Shape Correction Mask(512 power samples)	10 ⁻⁶	512*4	sl
13	Number of Noise Spectra averaged		4	ul
14	AGC (AGC_1 + AGC_2) Corrected	dB/100	4	sl (see note 3)
15	AGC_1 Command	dB/100	4	sl (see note 3)
16	AGC_2 Command	dB/100	4	sl (see note 3)
17	Number of Spikes from AUX_SIRDBF	-	2	us
18	Number of Spikes autodetected	-	2	us
17	Spare		16*1	uc
Total Size			2132 bytes	

Table 2.3.8.2-1: Cal 2 SARIn MDS Record Structure

Notes:

- 1) this is an exotic unit exclusively used at binary record level to improve resolution of the lat and long fields
- 3) This is an exotic unit used for db-units related fields.



Advanced Computer Systems



Instrument Processing Facility L1b

Doc. No.: CS-RS-ACS-GS-5106
 Issue: 4.0
 Date: 10/12/2007
 Page: 106

Deleted: 3.

Deleted: 2

Deleted: 3

Deleted: 07

2.3.9 Cal3 MDS Record Structure

This MDS is composed by:

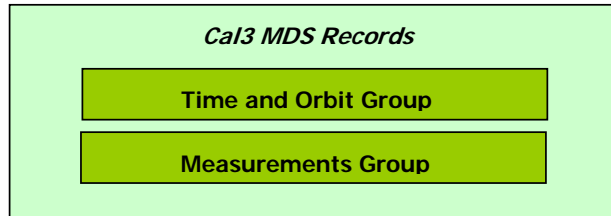

Proposed layout, extracted from [MSL-PS] is as follows:

Field	Description	Units	Bytes	Format
Time and Orbit Group				
1	Data Record Time (MDSR Time Stamp)	TAI	12	sl+2*ul
2	USO Correction Factor	10-9	4	sl
3	Mode ID		2	us
4	Source Sequence Counter		2	us (see note 6)
5	Instrument Configuration		4	ul
6	Record counter (always starting from 1)		4	ul
7	Latitude of measurement	10 ⁻¹ μdeg	4	sl (see note 1)
8	Longitude of measurement	10 ⁻¹ μdeg	4	sl (see note 1)
9	Altitude of COG above reference ellipsoid (interpolated value)	mm	4	ul
10	Instantaneous altitude rate derived from orbit	mm/s	4	ss
11	Satellite velocity vector[3] (in ITRF)	mm/s	3*4	sl
12	Real beam direction vector[3] (in CRF)	μm	3*4	sl
13	Interferometer baseline vector[3] (in CRF)	μm	3*4	sl
14	CAL3 Measurement Confidence Data (flag word) see table 2.3.5-2		4	ul
Measurements Group				
15	Window delay (2 way) instrument corrections applied	10-12 s	8	sll
16	Rate of change of window delay (one way)	10-12 s/s	4	sl
17	Ho Initial Height word	48.8 ps	4	sl (see note 2)
18	HPR Height Rate	3.05 ps/rc	4	sl (see note 2)



Advanced Computer Systems



Instrument Processing Facility L1b

Doc. No.: CS-RS-ACS-GS-5106
 Issue: 4.0
 Date: 10/12/2007
 Page: 107

Deleted: 3

Deleted: 2

Deleted: 3

Deleted: 07

19	Coarse Range word LAI	12.5 ns	4	sl (see note 2)
20	Fine Range word FAI	12.5 ns/256	4	sl (see note 2)
21	AGC channel 1 Corrected	dB/100	4	sl (see note 3)
22	AGC channel 2 Corrected	dB/100	4	sl (see note 3)
23	Total Fixed Gain Rx 1	dB/100	4	sl (see note 3)
24	Total Fixed Gain Rx 2	dB/100	4	sl (see note 3)
25	Transmit Power	microwatt	4	sl
26	Doppler Range Correction	mm	4	sl
27	Instrument range correction Tx-Rx antenna	mm	4	sl
28	Instrument range correction Rx only antenna	mm	4	sl
29	Instrument Gain correction Tx-Rx antenna	dB/100	4	sl (see note 3)
30	Instrument Gain correction Rx only antenna	dB/100	4	sl (see note 3)
31	Internal Phase Correction	micro-rad	4	sl
32	External Phase Correction	microrad	4	sl
33	Noise Power Measurement	dB/100	4	sl (see note 3)
34	Retracked Range	mm	4	sl
35	Retracked Bin Position	Bins/100	4	sl (see note 4)
36	Power at retracked point	(scaled)	4	sl
37	Interferometric Phase Difference ($-\pi - \pi$) at retracked point	micro-rad	4	sl
38	Coherence at retracked point	1/1000	4	sl
39	Averaged Power Echo Waveform [128]	Scaled	128*2	us
40	Averaged Coherence [128]	1/1000	128*2	ss
41	Averaged phase difference ($-\pi - \pi$)	micro-rad	128*4	sl
42	Echo Scale Factor (to scale echo to watts)	-	4	sl
43	Echo Scale Power (power of 2)	-	4	sl
44	Number of Echoes Averaged		2	ss
45	Flags		2	us
46	Spare		12*1	uc
Total Size			1232	bytes

Table 2.3.7-1: Cal3 Level1b MDS Record Structure

Notes:

1) this is an exotic unit exclusively used at binary record level to improve resolution of the lat and long fields

 <p>Advanced Computer Systems</p>		<p><i>Instrument Processing Facility L1b</i></p> <p>Doc. No.: CS-RS-ACS-GS-5106 Issue: 4.0 Date: 10/12/2007 Page: 108</p>
--	---	--

- Deleted: 3.
- Deleted: 2
- Deleted: 3
- Deleted: 07
- Deleted: exotic

- 2) These are exotic units specific of SIRAL instrument
- 3) This is an exotic unit used for db-units related fields.
- 4) This is an exotic unit specifically introduced for the CAL3 L1B product binary record description
- 6) The field Source Sequence Counter is copied from LRM L0 for LRM FBR – from ECHO-SAR L0 –first packet of group for FBR SAR – ECHO-SARIN L0 of Master channel, first packet of group, for FBR SARIN.

Fields Description:

Field 1) MDSR Time Stamp - Averaged from the time stamps of 21 input records over approx 1 Second

Field 2) USO Correction factor (definition tbd) - this is the correction factor for USO drift

Field 3) ID - Identifies the measurement mode. see Table 2.3.3-2

Field 4) Source Sequence Counter - blank (=0)

Field 5) Instrument Config - flag. see Table 2.3.3-3

Field 6) Record counter - will always be 1 for files containing a single output record.

Field 7) latitude of measurement - corresponding to the MDSR Time Stamp and therefore the centre of the CAL3 measurement sequence.

Field 8) longitude of measurement - (as for Latitude)

Field 9) Altitude - - altitude of the Satellite CoM above reference ellipsoid - (as for Latitude)

Field 10) Altitude rate - (as for Latitude)

Field 11) Satellite velocity vector - in International Terrestrial Reference Frame in the International Earth Fixed System.

Field 12) Real beam direction vector - in Cryosat Reference Frame,

Field 13) Interferometer baseline vector - in Cryosat Reference Frame,

Field 14) CAL3 MCD - Measurement confidence flags. See Table 2.3.7-2



Advanced Computer Systems



Instrument Processing Facility L1b

Doc. No.: CS-RS-ACS-GS-5106
Issue: 4.0
Date: 10/12/2007
Page: 109

Deleted: 3

Deleted: 2

Deleted: 3

Deleted: 07

Definition	PDS Bit	SS Bit	Setting
CAL 3 Degraded	31	0	0 = OK, 1=degraded
L1 input MCD errors	30	1	0=OK, 1= errors in L1 input file
Datation error	29	2	0=OK, 1= error in input datation field
Location error	28	3	0=OK, 1= error from orbit CFI
Input sequence error	27	4	0=OK, 1= error in sequence of input records (eg gaps)
Short sequence	26	5	0=OK, 1= input shorter than expected
Long sequence	25	6	0=OK, 1= input longer than expected
Reserved	24-0	7-31	set to 0

Table 2.3.7-2 CAL3 L1B MCD

Field 15) Window delay - The minimum window delay from the burst read in from the CAL3 FBR data. All the echoes are aligned to this value before they are averaged.

Field 16) Rate of change of Window delay - over 1 second

Field 17) H0 - from telemetry

Field 18) COR2 - on-board tracker height rate over the radar cycle

Field 19) Coarse range word LAI - derived from telemetry

Field 20) Fine range word - derived from telemetry

Field 21) AGC ch 1 - AGC gain applied on Rx channel 1. Gain calibration corrections are applied. (Sum of AGC stages 1 and 2 plus the corresponding corrections)

Field 22) AGC ch 2 - AGC gain applied on Rx channel 2. Gain calibration corrections are applied.

Field 23) Total Fixed Gain On Channel 1 - total fixed instrument gain applied on chain 1, this is the Gain applied by the RF unit.

Field 24) Total Fixed Gain On Channel 2 - instrument fixed gain on receive chain 2 (as for chain 1)

 <p>Advanced Computer Systems</p>		<p><i>Instrument Processing Facility L1b</i></p> <p>Doc. No.: CS-RS-ACS-GS-5106 Issue: 4.0 Date: 10/12/2007 Page: 110</p>
--	---	--

- Deleted: 3
- Deleted: 2
- Deleted: 3
- Deleted: 07

Field 25) Transmit power in micro Watts.

Field 26) Doppler range correction - computed for the component of satellite velocity in the nadir Direction

Field 27) Instrument Range Correction (Tx-Rx chain) - Calibration correction to range on channel 1 computed from CAL1

Field 28) Instrument Range Correction (Rx chain) - Calibration correction to range on channel 2 computed from CAL1

Field 29) Instrument Gain Correction (Tx-Rx chain) - Calibration correction to gain on channel 1 computed from CAL1

Field 30) Instrument Gain Correction (Rx chain) - Calibration correction to gain on channel 2 computed from CAL1

Field 31) Internal phase correction. - reserved for future use

Field 32) External phase correction. - reserved for future use

Field 33) Noise power measurement - converted from telemetry units to be the noise floor of FBR measurement echoes

Field 34) Retracked Range - Computed from retracking the averaged power echo. It is a one-way measurement in mm.

Field 35) Retracked Bin Position - The retracking point in terms of range window bins. Dividing the integer value by 1000 gives the retracked point in fractional bins. Bins are numbered from 0 to 127.

Field 36) Power at retracked point - power in the echo at the retracked position given in field 35. To convert this power to Watts the scaling in field 42. and field 43. must be applied.

Field 37) Interferometric phase difference at retracked point - phase difference from the echo at the retracked position given in field 35.

Field 38) Coherence at retracked point - coherence from the echo at the retracked position given in field 39 This is an indicator of quality or confidence for the retracked range and phase

Field 39) Averaged Power Echo - Array of 128 bins. Averaged from 21 echoes in the CAL3 measurement sequence (approx 1 second of measurement time)

Field 40. Averaged Coherence - Array of 128 bins. Averaged from 21 echoes in the CAL3 measurement sequence (approx 1 second)

 <p>Advanced Computer Systems</p>		<p><i>Instrument Processing Facility L1b</i></p> <p>Doc. No.: CS-RS-ACS-GS-5106 Issue: 4.0 Date: 10/12/2007 Page: 111</p>
--	---	--

- Deleted: 3
- Deleted: 2
- Deleted: 3
- Deleted: 07

Field 41) Averaged Phase Difference - Array of 128 bins. Averaged from 21 echoes in the CAL3 measurement sequence (approx 1 second)

Field 42) Echo Scale factor 'A' (to scale echo to Watts)

Field 43) Echo Scale power 'B' (power of 2 to scale echo to Watts) the formula for converting the echo to Watts is: **Power in Watts = counts * (A*10⁻⁹) * 2^B**

Field 44). Number of Echoes averaged - variable

Field 45) CAL3 Flags - see Table 2.3.7-3.

Field 46) Spares - set to 0.

Definition	PDS Bit	SS Bit	Setting
Time Delay too Large	15	0	0 = OK, 1 = Error
Time Delay too Small	14	1	0 = OK, 1 = Errors in L1 input file
Power Larger than Expected	13	2	0 = OK, 1 = Error
Power Lower than Expected	12	3	0 = OK, 1 = Error
Empty Waveforms Detected	11	4	0 = OK, 1 = some input echoes had zero power
Reserved	10-0	5-15	Set to zero

Table 2.3.7-3 CAL3 Flags



Advanced Computer Systems



Instrument Processing Facility L1b

Doc. No.: CS-RS-ACS-GS-5106
 Issue: 4.0
 Date: 10/12/2007
 Page: 112

Deleted: 3.

Deleted: 2

Deleted: 3

Deleted: 07

3 CRYOSAT LEVEL-1 PRODUCTS

The following table provides the Product ID for each product generated by the IPF1.

Product ID	Description
SIR1LRM_FR	Level 1 FBR LRM Mode (Rx1 Channel)
SIR1FDM_FR	Level 1 FBR Fast Delivery Ocean (Rx1 Channel)
SIR2LRM_FR	Level 1 FBR LRM Mode (Rx2 Channel)
SIR2FDM_FR	Level 1 FBR Fast Delivery Ocean (Rx2 Channel)
SIR1SAR_FR	Level 1 FBR SAR Mode (Rx1 Channel)
SIR2SAR_FR	Level 1 FBR SAR Mode (Rx2 Channel)
SIR_SIN_FR	Level 1 FBR SARin Mode
SIR_SIC3FR	Level 1 FBR CAL3 Mode
SIR_LRM_1B	Level-1 Product Low Rate Mode
SIR_FDM_1B	Level-1 Product Fast Delivery Ocean
SIR_SAR_1B	Level-1 SAR Mode
SIR_SIN_1B	Level-1 SARin Mode
SIR1LRC11B	Level-1 CAL1 Low Rate Mode (Rx1 Channel)
SIR2LRC11B	Level-1 CAL1 Low Rate Mode (Rx2 Channel)
SIR1SAC11B	Level-1 CAL1 SAR Mode (Rx1 Channel)
SIR2SAC11B	Level-1 CAL1 SAR Mode (Rx2 Channel)
SIR_SIC11B	Level-1 CAL1 SARin Mode
SIR_SICC1B	Level-1 CAL1 SARIN Exotic Data
SIR1SAC21B	Level-1 CAL2 SAR Mode (Rx1 Channel)
SIR2SAC21B	Level-1 CAL2 SAR Mode (Rx2 Channel)
SIR1SIC21B	Level-1 CAL2 SARin Mode (Rx1 Channel)
SIR2SIC21B	Level-1 CAL2 SARin Mode (Rx1 Channel)
SIR_SIC31B	Level-1 CAL3
SIR1LRM_OM	LRM and TRK Monitoring Data from Rx 1 Channel
SIR2LRM_OM	LRM and TRK Monitoring Data from Rx 2 Channel
SIR1SAR_OM	SAR Monitoring Data from Rx 1 Channel
SIR2SAR_OM	SAR Monitoring Data from Rx 1 Channel
SIR_SIN_OM	SARIN Monitoring Data
SIR_SIC40M	CAL4 Monitoring Data

Table 3-1: Level-1 products list

 <p>Advanced Computer Systems</p>		<p>Instrument Processing Facility L1b</p> <p>Doc. No.: CS-RS-ACS-GS-5106</p> <p>Issue: 4.0</p> <p>Date: 10/12/2007</p> <p>Page: 113</p>
--	---	---

- Deleted: 3
- Deleted: 2
- Deleted: 3
- Deleted: 07

3.1 FILE NAMES

The file name of each Level-1 product will follow [what specified in \[MASTER-ICD\]., i.e.:](#)

- Deleted: the recommendation shown in [FMT-GUIDE] at section 4.1, that is:
- Deleted: vvvv
- Deleted: vvvv

MM_CCCC_TTTTTTTTTT_yyyymmddThhmmss_YYYYMMDDTHHMMSS_bvvv.HDR
MM_CCCC_TTTTTTTTTT_yyyymmddThhmmss_YYYYMMDDTHHMMSS_bvvv.DBL

where

MM is the mission identifier *CS* for Cryosat

CCCC is the file class (i.e.: OPER for routine operation, NRT_ for Near Real Time, RPR0 for Reprocessing, TEST for Testing or Tlxx for stand alone IPF1 testing associated to Test Data Sets tagged as Tlxx, LTA_ for products generated in the Long Term Archive).

TTTTTTTTTT is the file type and corresponds to the Product ID of the Table 3-1

yyymmddThhmmss is the validity start time and correspond to the input Level 0 start time

YYYYMMDDTHHMMSS is the validity stop time and correspond to the input Level 0 stop time

b is the baseline identifier as read-in from the PCONF

v is the version number

- Deleted: v

For example in case of an operational Level-1 product of the SIRAL instrument in Low Rate Mode [in baseline number A and version 1](#) the name could be:

CS_OPER_SIR_LRM1B_20030624T075728_20030624T080231_A001.HDR
CS_OPER_SIR_LRM1B_20030624T075728_20030624T080231_A001.DBL

- Deleted: 0
- Deleted: 0

The file with extension *.HDR* is the xml Header and the file with the extension *.DBL* is the Level 0 Product file following the format of the correspondent ENVISAT one.

END OF DOCUMENT

28	Spare		1	uc
----	-------	--	---	----